

Ingénierie et eXpertise des Ouvrages

juin-24

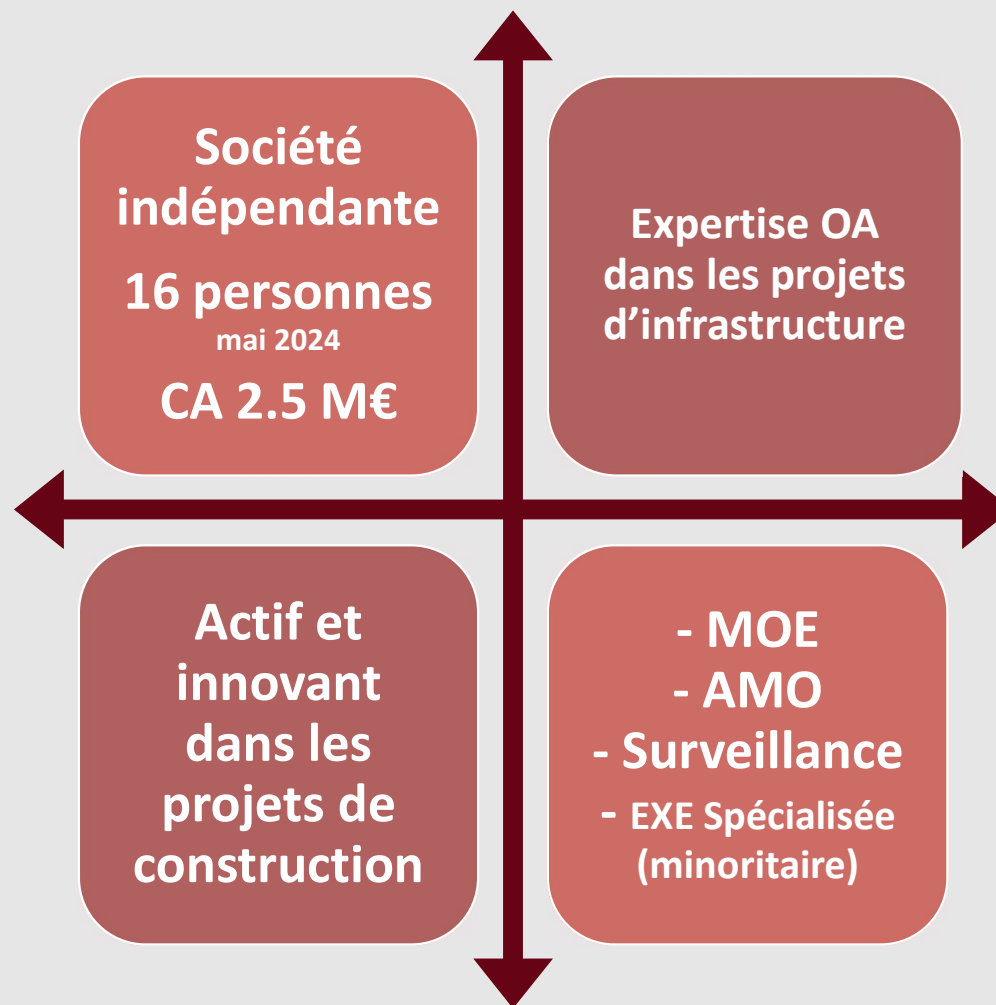



Notre rayon d'actions



Domaine

- Ouvrages d'art (80%)
- Ouvrages souterrains
- Ouvrages de gros Génie-Civil

Capacité à s'interfacer et nouer des partenariats

- Inscription dans des projets multimétiers, notamment routiers
- Missions prototypes et/ou R&D

Certificat de Qualification

OPQIBI

N° 24 06 5769



Notre rayon d'actions



Notre expertise pour vos projets:

- Plusieurs experts ayant plus de 10 ans d'expérience dans la conception des ouvrages d'art, sur de grands projets,
- Expérience dans la coordination de compétences transverses : environnement, architecture, tracé...
- Etudes de tous types de structures (BP, câbles, mixte, métal), des fondations au tablier
- La prise en compte de l'entretien de l'ouvrage dès la conception

Experts représentés dans les groupes de travail des associations:

- AIPCR
- IMGCC

Enseignement:

- INSA Lyon
- Mine d'Ales



Une société tournée vers l'innovation



Quelques exemples:



Conception d'application de béton BFUP

- Renforcement
- Étanchéité
- Ouvrage neufs



Une société tournée vers l'innovation



Quelques exemples:

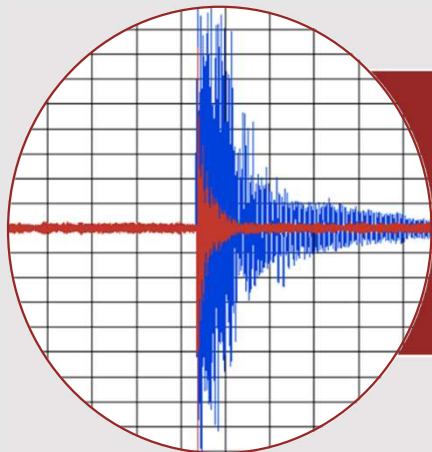

Instrumentation

- Utilisation de CFOD (Capteurs Fibres Optiques Distribués)
- Surveillance acoustique d'ouvrages câblés, par mise en réseau d'unités autonomes et connectées



ORGANIGRAMME

Adrien ROIBET
Président / Fondateur

Eric HELIN
Expert associé

Jean-Philippe MAHERAULT
Dir. SHM / Co-Fondateur

Liza NASARRE
Assistante Dir + Comm

Vanessa SCHREINER
Responsable administrative

Grand Ouest

Jean Philippe MAHERAULT
Directeur SHM

Aurélien CROZE
(Chargé d'instrumentation)

Nicolas CHALAYE
(Chargé d'instrumentation)

Siège Lyon

Aurélien CROZE
Responsable Patrimoine

Etienne VULIN
Responsable des Etudes

Antoine SUZON (Ingénieur Ouvrages d'Art)
Thomas BLAYAC (Ingénieur Ouvrages d'Art)
Dylan BESSE (Ingénieur Ouvrages d'Art)
Paul GOGUEY (Ingénieur Ouvrages d'Art)
Manon GUILLOU (Ingénieure OA - DET)
Nicolas CHALAYE (Ingénieur Ouvrages d'Art)
Fanny CHAMBARD (Ingénieure OA – Contrat Pro)
Thibaut ROUSSOT (Technicien Projeteur OA)
Colin MAES (Technicien Projeteur OA)



Implantation



Agence
Grand Ouest
(Saint Nazaire
120 m²)

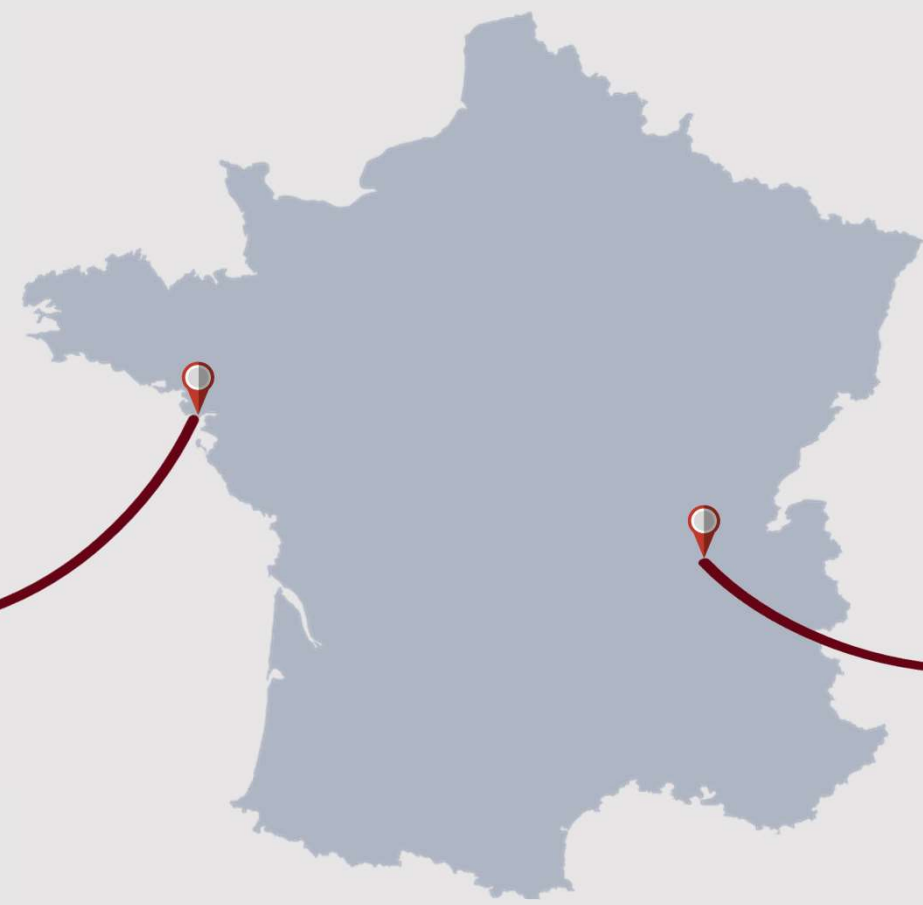

Siège Lyon
(Jonage 300
m²)

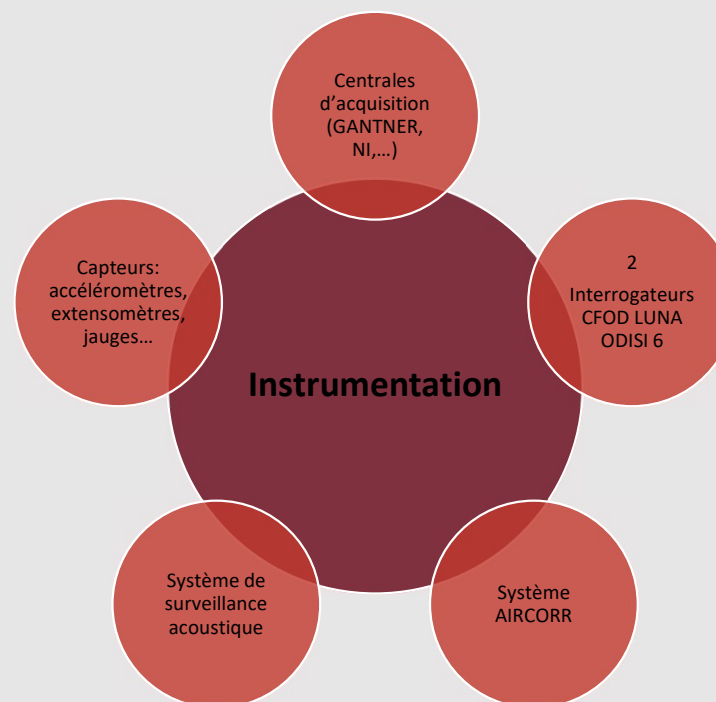
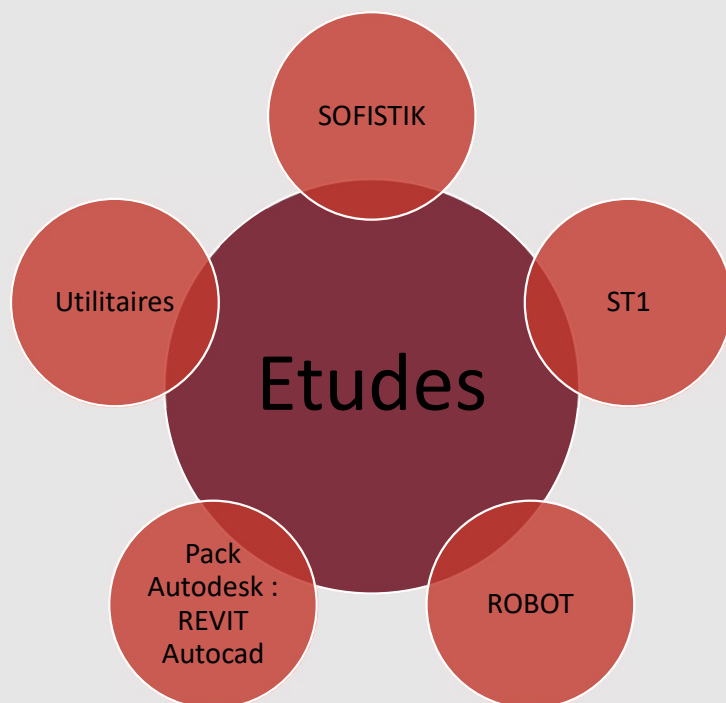



Référence étude conception



Rouen Métropole – Pont Nikki de Saint-Phalle – MOE Complète (AVP=>AOR)

Partenaire: Atelier RITZ (CO-t)

Coût travaux: env. 10 M€ HT



juin-24

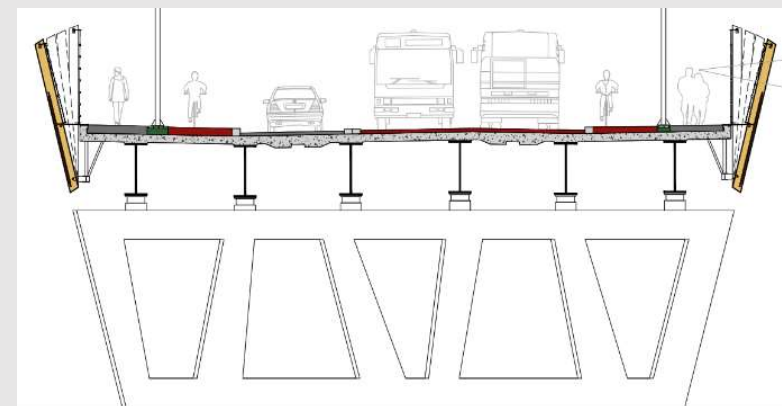



Référence MOE conception / travaux



Commune de Saint Claude – Pont de la Pipe

- Expertise et MOE complète (AVP/PRO, ACT, DET) – ouvrage semi-intégral

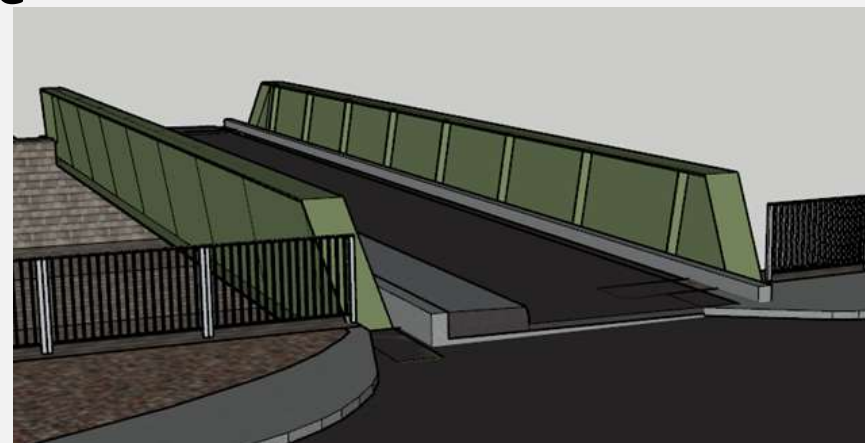

juin-24



Référence MOE conception / travaux



CD74 – Passerelle SNCF

- MOE Complète (AVP → DET)
- Interface SNCF (DCS)
- Interfaces Réseaux (ENEDIS, GAZ)

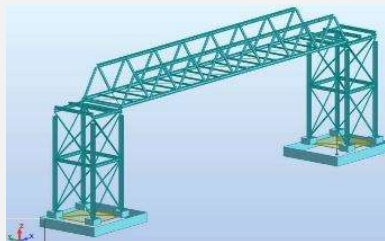

juin-24



Référence MOE conception / travaux



CD05 – Pont Neuf - Embrun

- MOE Conception
- Démolition reconstruction
- Ouvrage neuf mixte bois BFUP

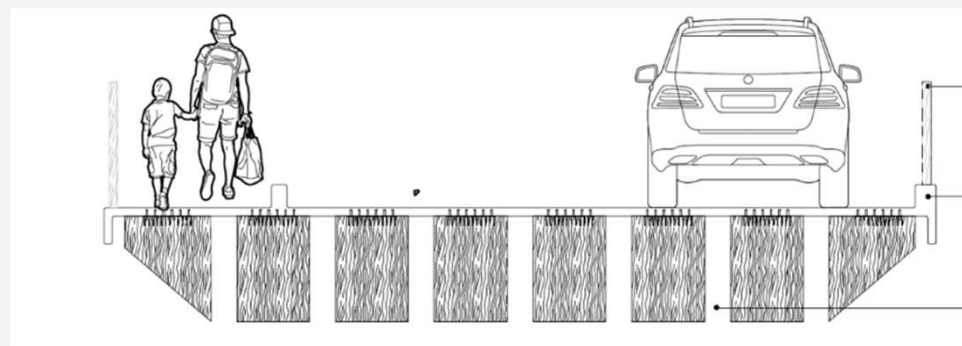
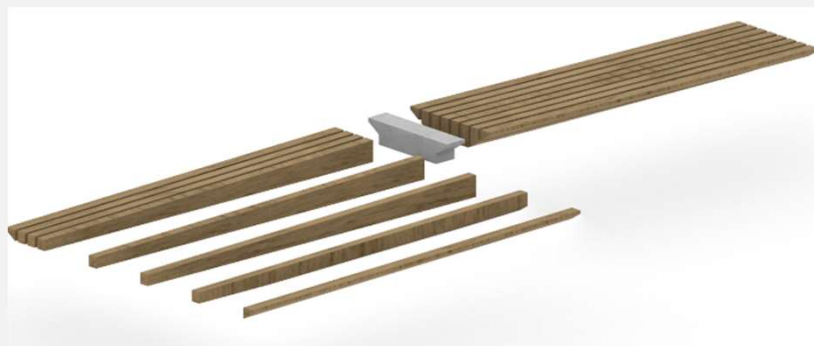

juin-24



Référence MOE conception / travaux



CD38 – Pont de Oulles

- MOE Générale (AVP -> DET)
- Démolition reconstruction
- Ouvrage en milieu montagneux
- Phasage complexe

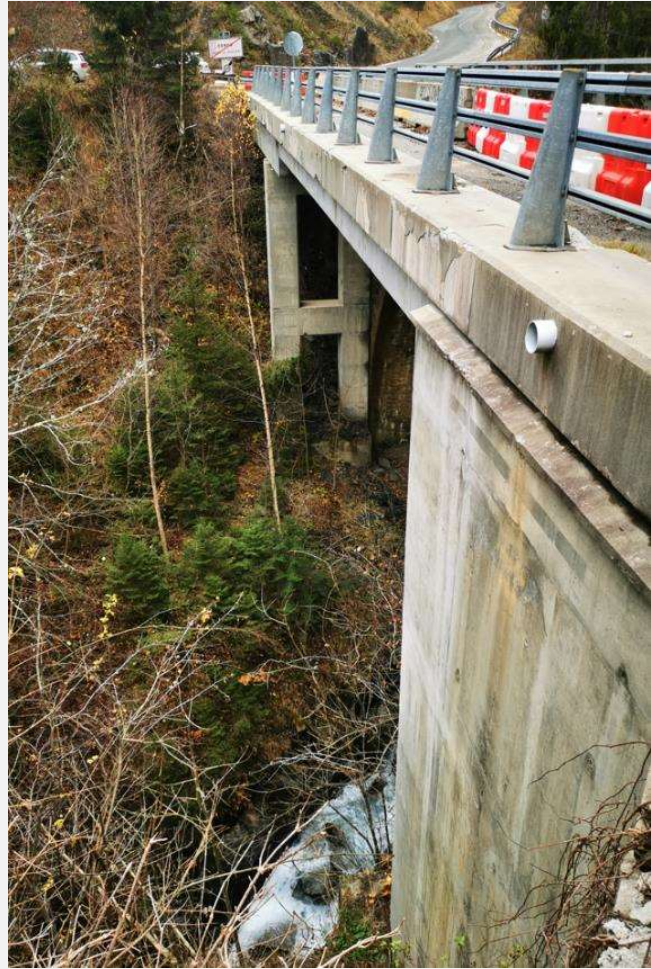
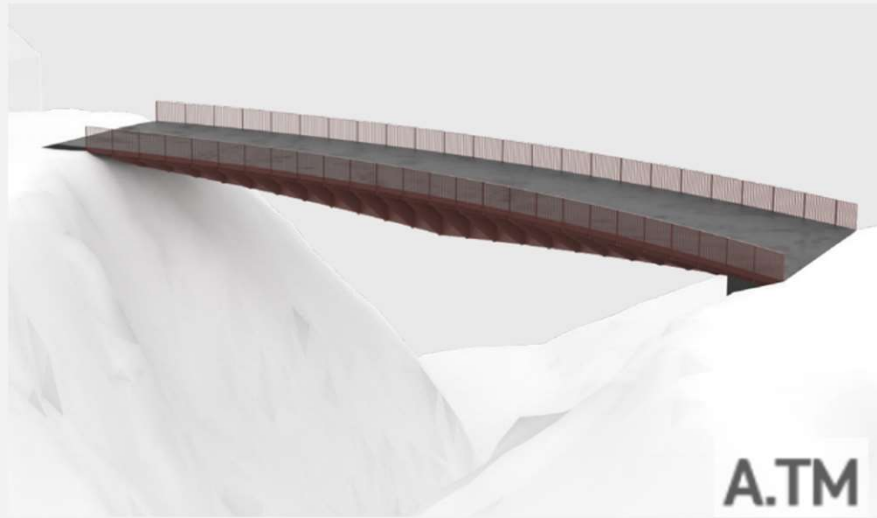
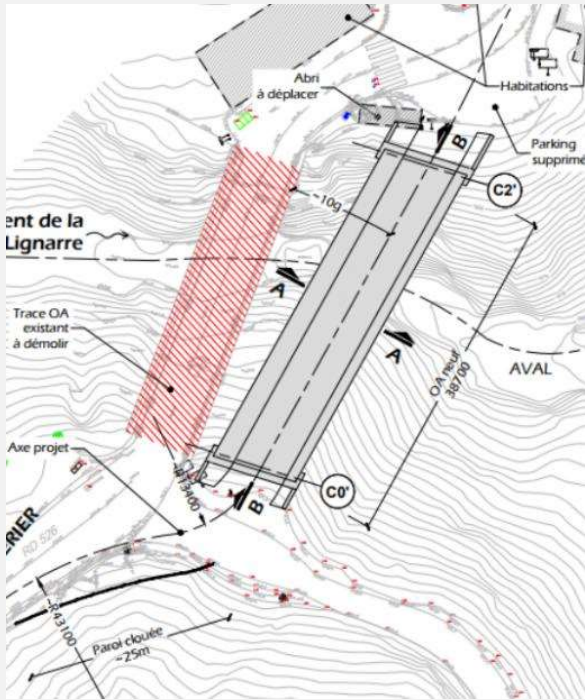
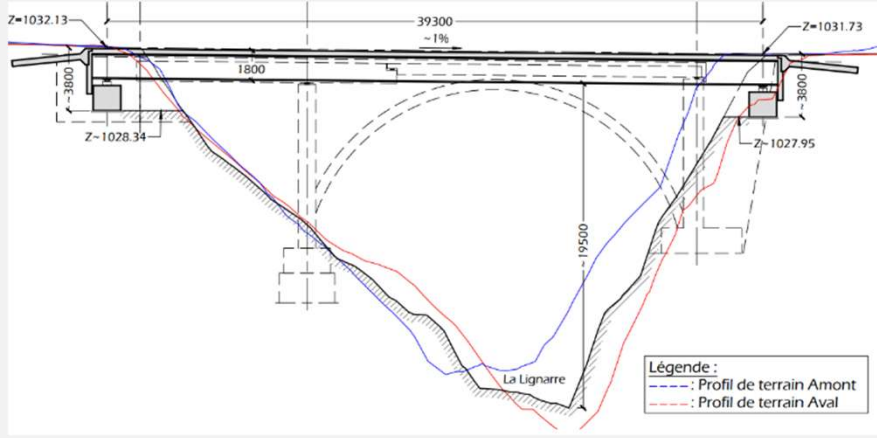



Référence étude conception

APRR – Remplacement du PI3004 – AVP – AMO Conception Réalisation

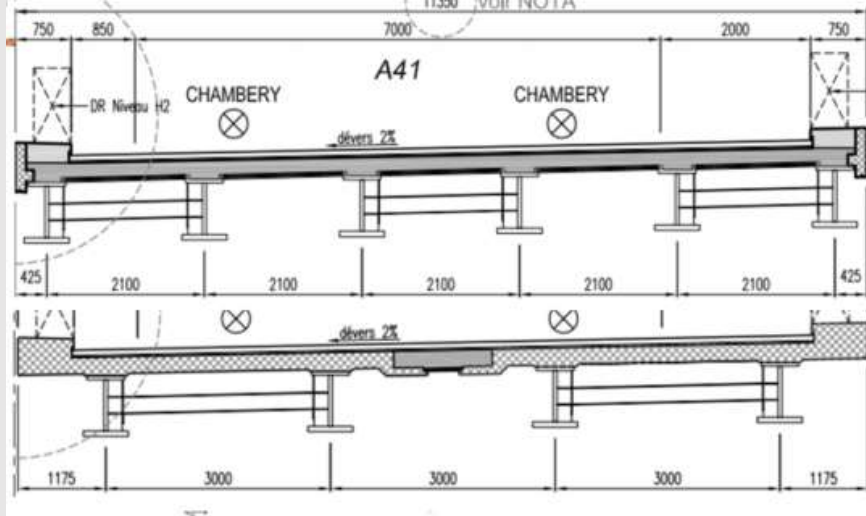

About intégral (pour mémoire)

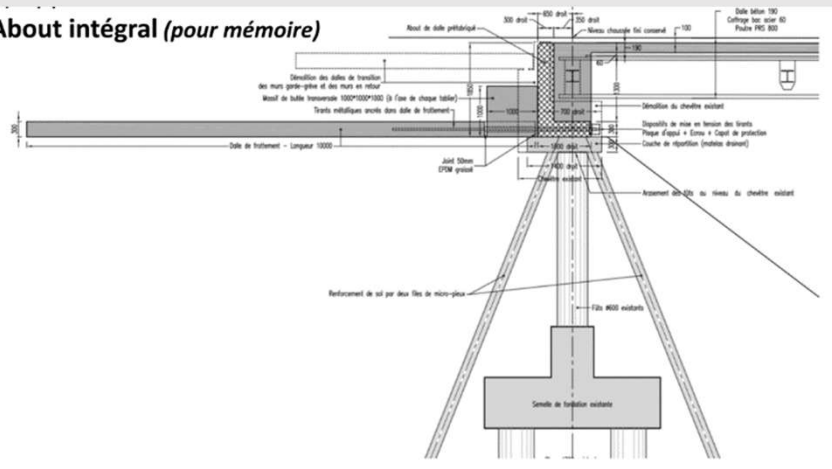

2 x 4 câbles STUP 12T13 TBR

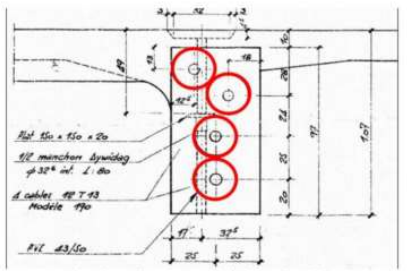

Plan de précontrainte à l'about du tablier

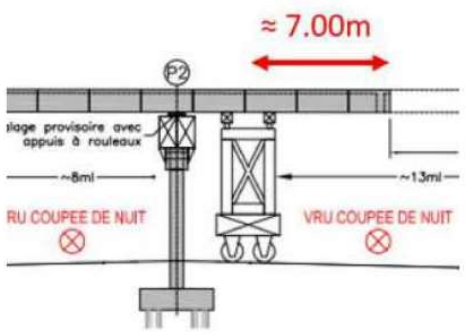



Référence maintenance - réparation



CCI Seine Estuaire – Pont de Normandie

- MOE remplacement des haubans et câbles (avec ARTCAD et TRAVEE)
 - 21 câbles de prec / 12 haubans (2022 – 2027)
- Réparation des gaines
- Secrétaire comité technique
- Recalcul général

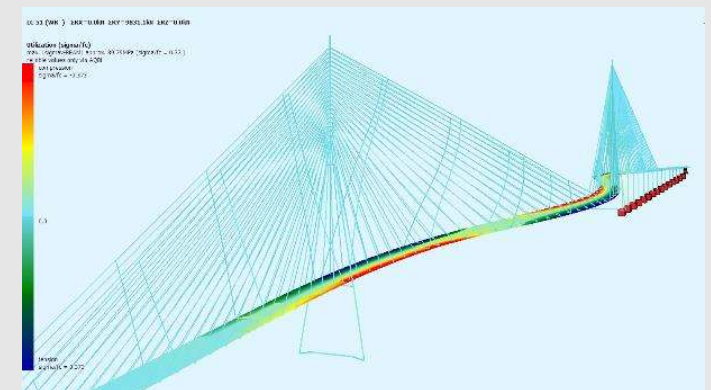
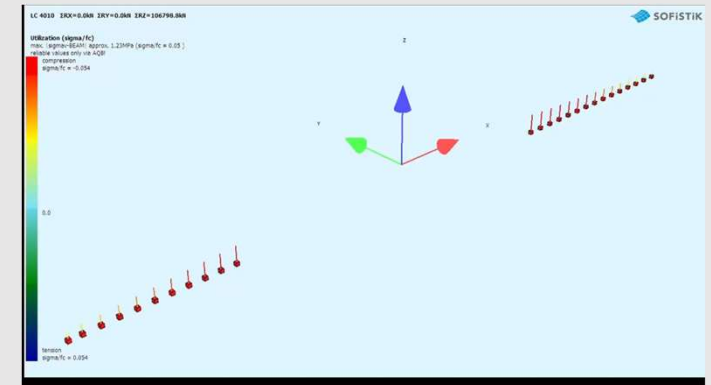



Référence maintenance - réparation



CCI Seine Estuaire – Pont de Tancarville

- Contrôle extérieur travaux sur VIPP
- OPC général / AMO planification
- AMO DIAG dalle Robinson



juin-24



Référence maintenance - réparation

CCI Seine Estuaire – Pont de Tancarville

- Expertise Incendie
- Pilotage Diagnostic
- Mesures conservatoires
- Réparation

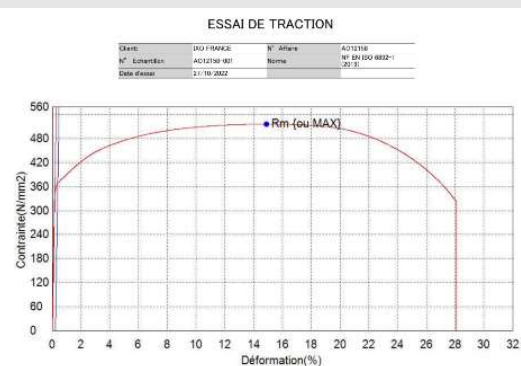

juin-24



Référence – Réhabilitation - Elargissement



CD01 – Pont de Frans / Jassans Riottier

Elargissement modes doux de l'existant

- MOE générale
- Réhabilitation ouvrage métallique
- Elargissement modes doux

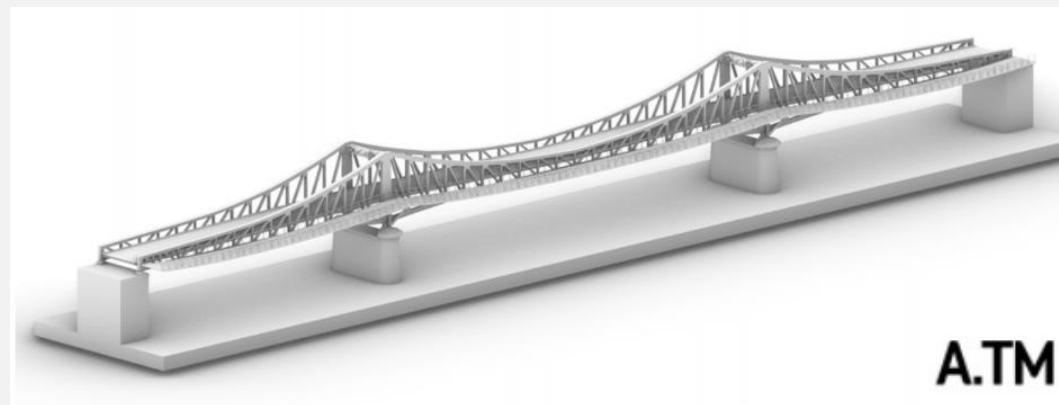
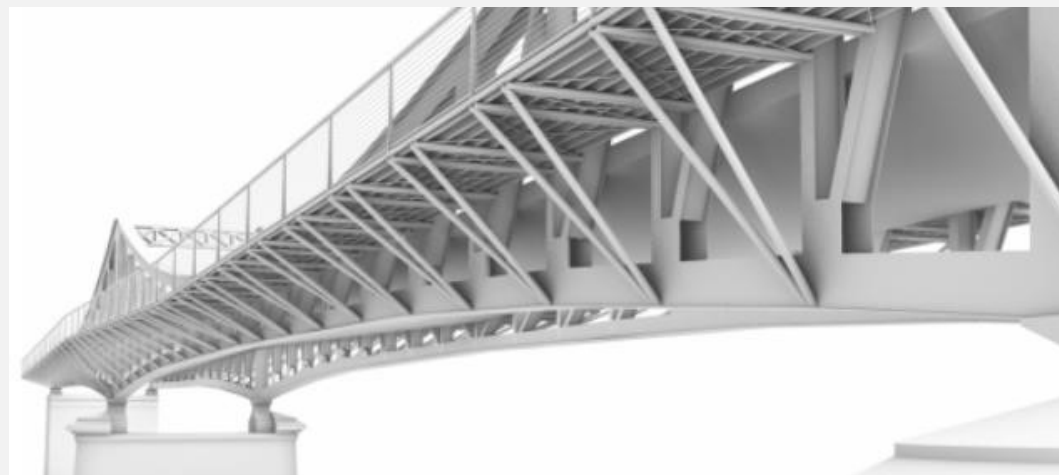



Référence – Réhabilitation - Elargissement



CD38 – Lagnieu

Elargissement modes doux de l'existant

- Diagnostic – Recalcul général
- Etudes préliminaires
- Etudes de renforcement

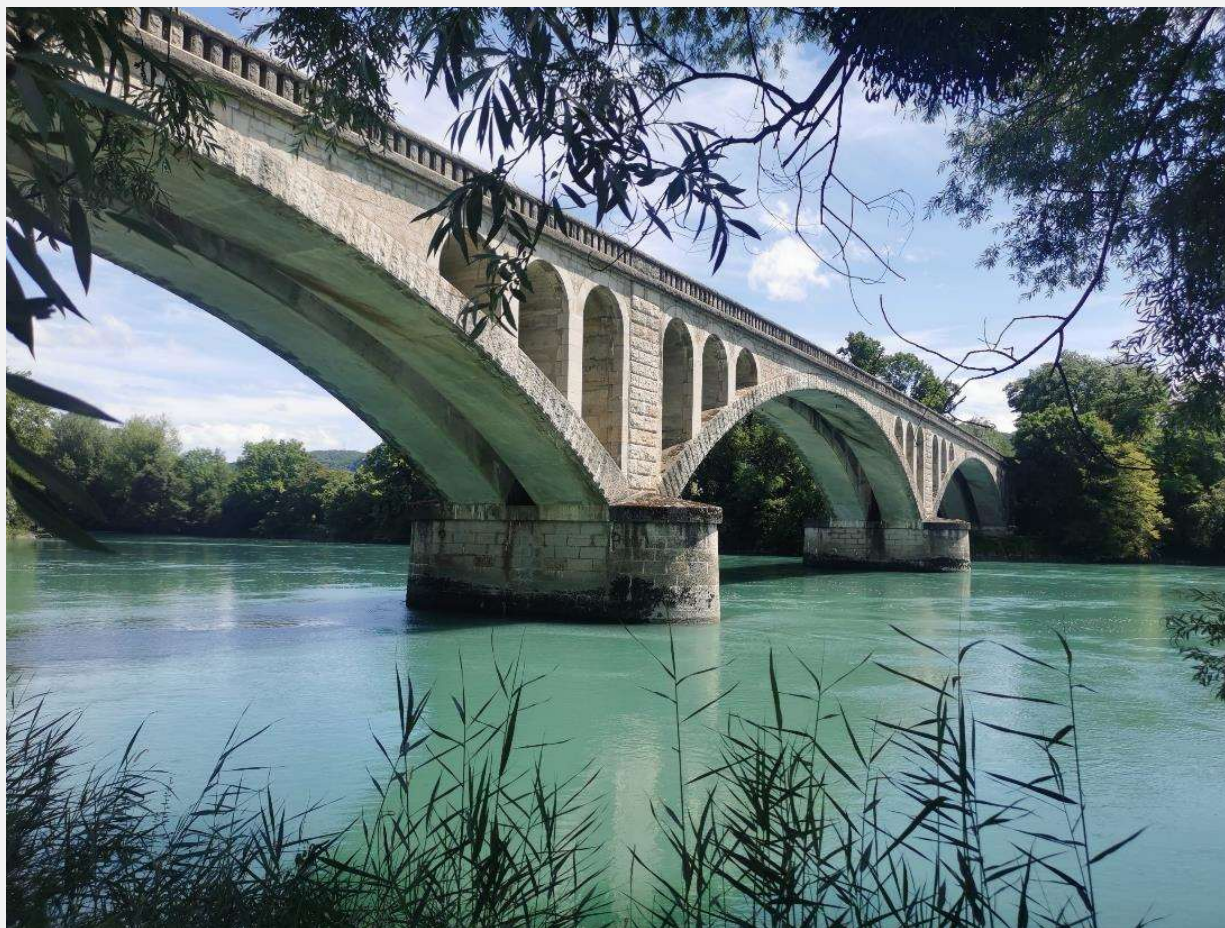
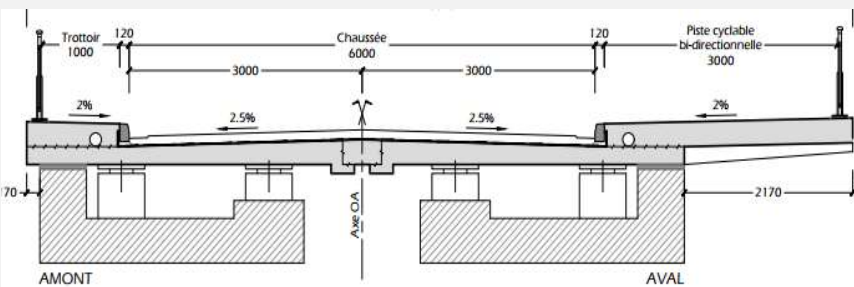
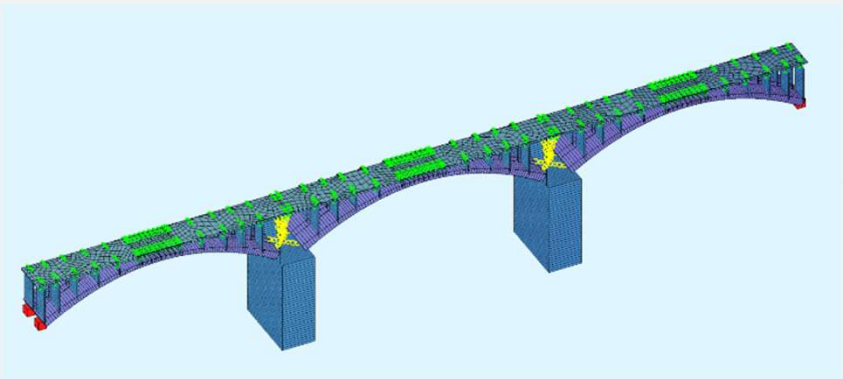

juin-24



Référence – Réhabilitation - Elargissement



CD69 – Pont de Belleville

Elargissement modes doux de l'existant

- Faisabilité réhabilitation et élargissement



juin-24



Référence – Réhabilitation - Elargissement



CD63 - DALLET – Réhabilitation BFUP

- **Elargissement modes doux** et réhabilitation BFUP
- Etudes EXE - Recalcul général (ST1 phasé / Robot)
- Etudes exécution charpente métallique

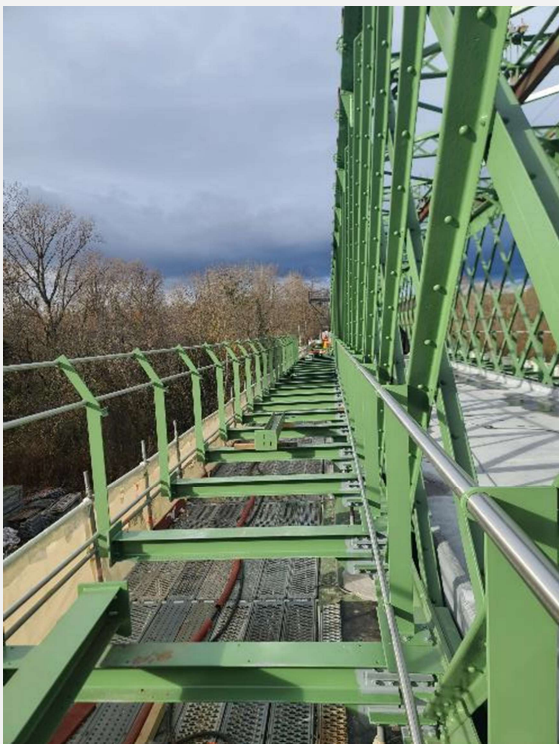
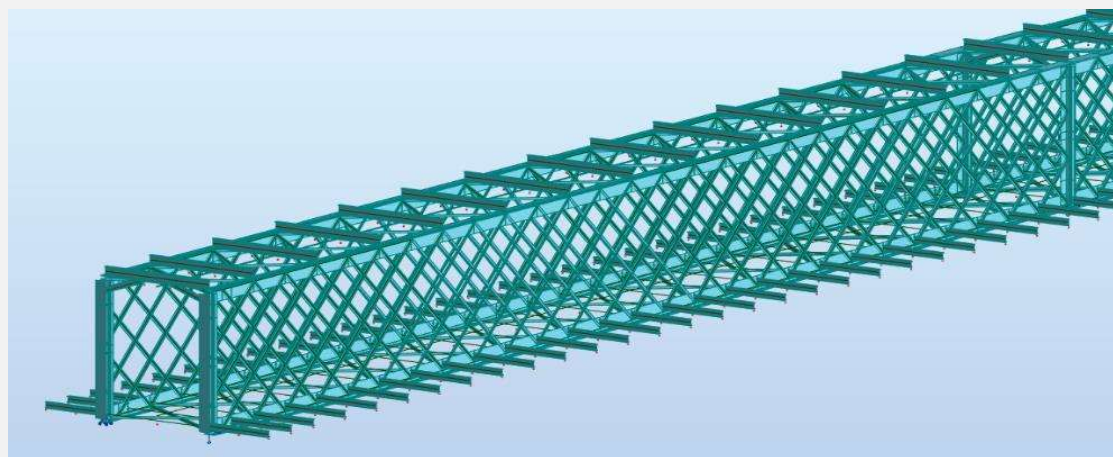

juin-24



Référence maintenance – réparation - MOE



Grand Lyon – Pont Maréchal Juin

- AMO / Expertise / MOE conception et réalisation –
- Réparation innovante

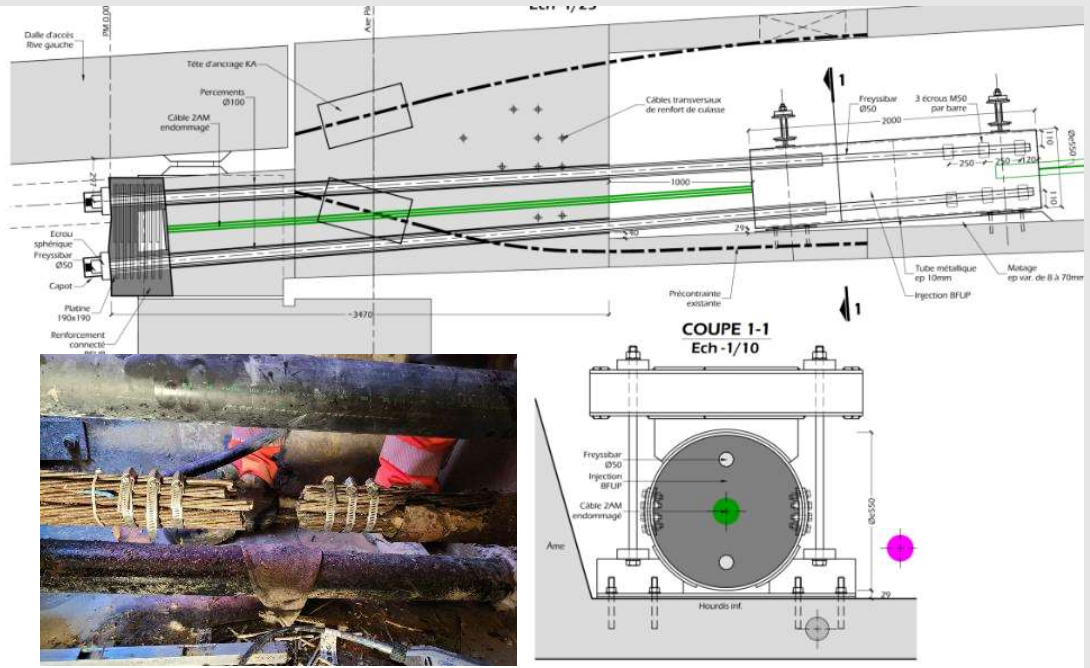

juin-24



Référence maintenance – réparation - MOE



Grand Annecy - Viaduc du Thiou

- Réparation BFUP d'un câble endommagé
- MOE conception et réalisation



juin-24



Référence réparation - MOE



VILLE DE GAP

- Travaux de confortement et de modernisation du viaduc du Buzon

Un ouvrage très proche de la ruine nécessitant des travaux d'urgence



Fracture décimétrique d'une pile-culée



Pile-culée après travaux d'urgence





Référence maintenance - réparation



Ponts suspendus

Diagnostics

Expertises

Pont de l'Abîme



Pont de Vernaison



Passerelle Saint Vincent





Référence maintenance - réparation



Pont de Groslée (CD01)

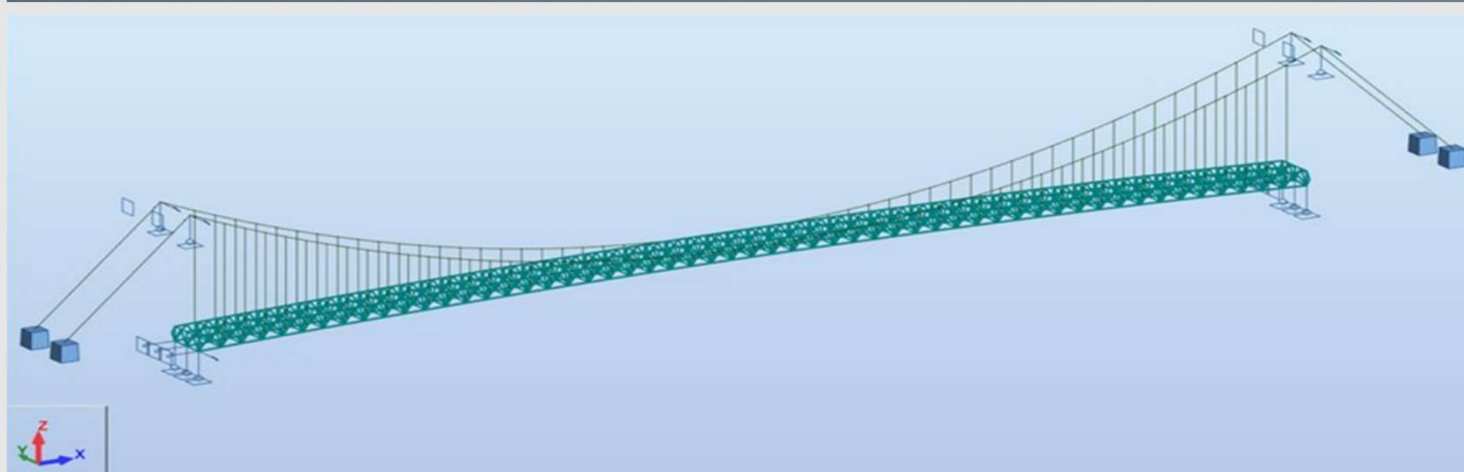
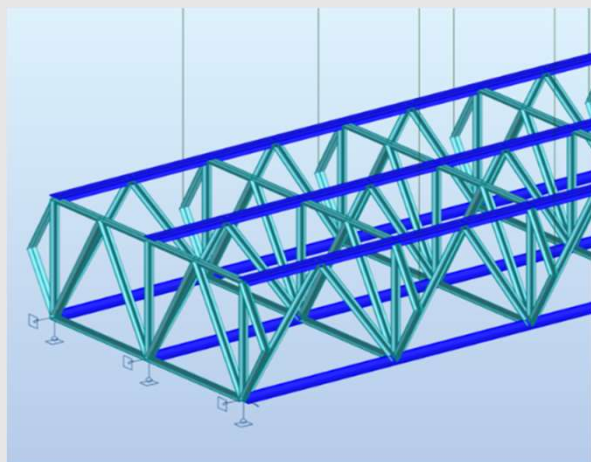

juin-24



Référence maintenance - réparation



AREA – Viaduc de Monestier

- Expertise des appuis
- Vérification structurelle sous déplacements géotechniques

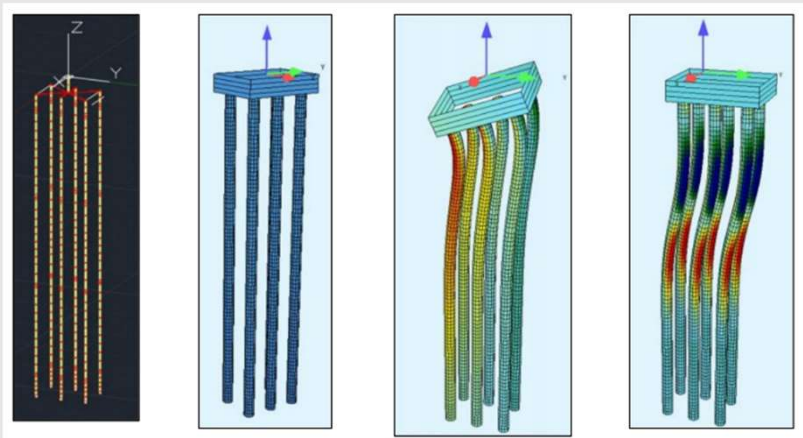



Référence maintenance - réparation

Tunnel du Mont Blanc

- AMO Technique
- AVP réparations dalles

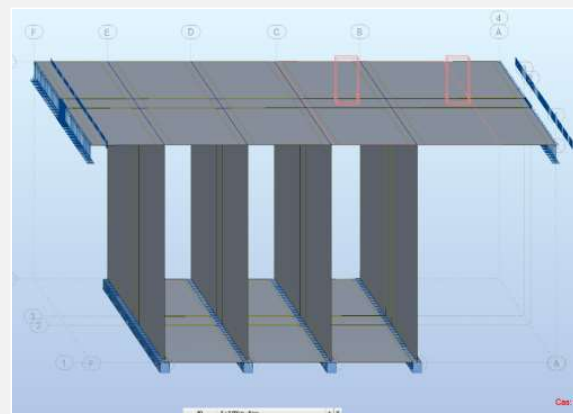
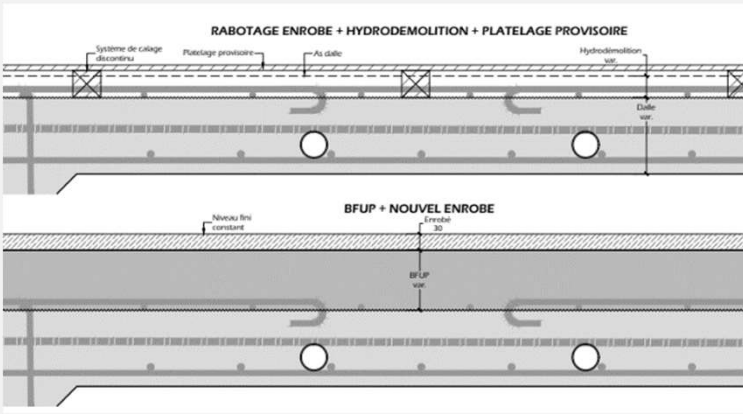
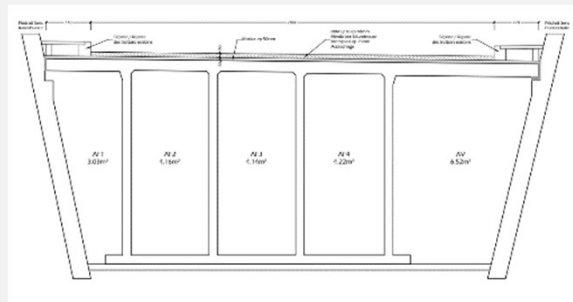
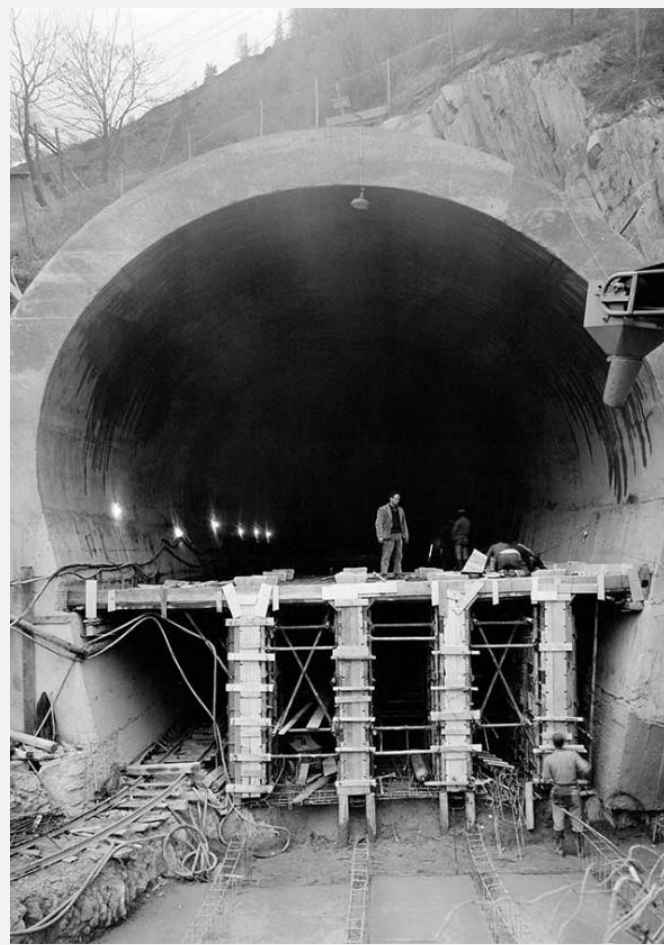

juin-24



Référence étude d'EXE spécifique



VICAT (Montalieu (38)) / Campenon Bernard – Silo à Clinker 89 000 Tonnes

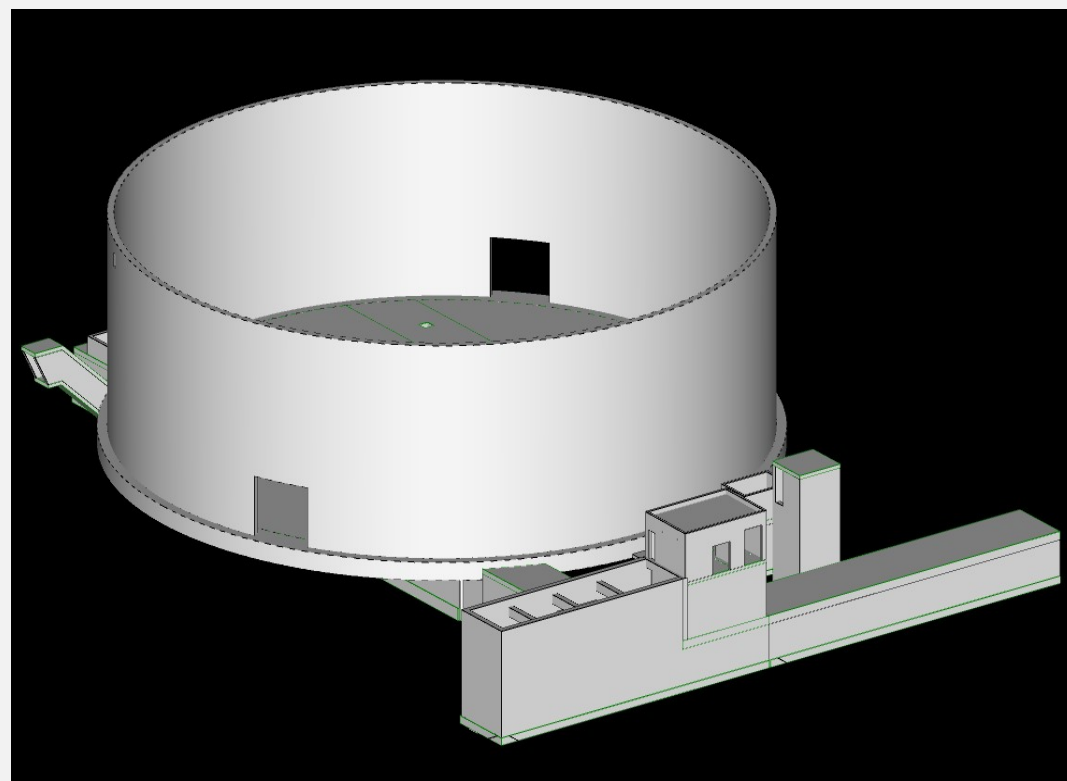
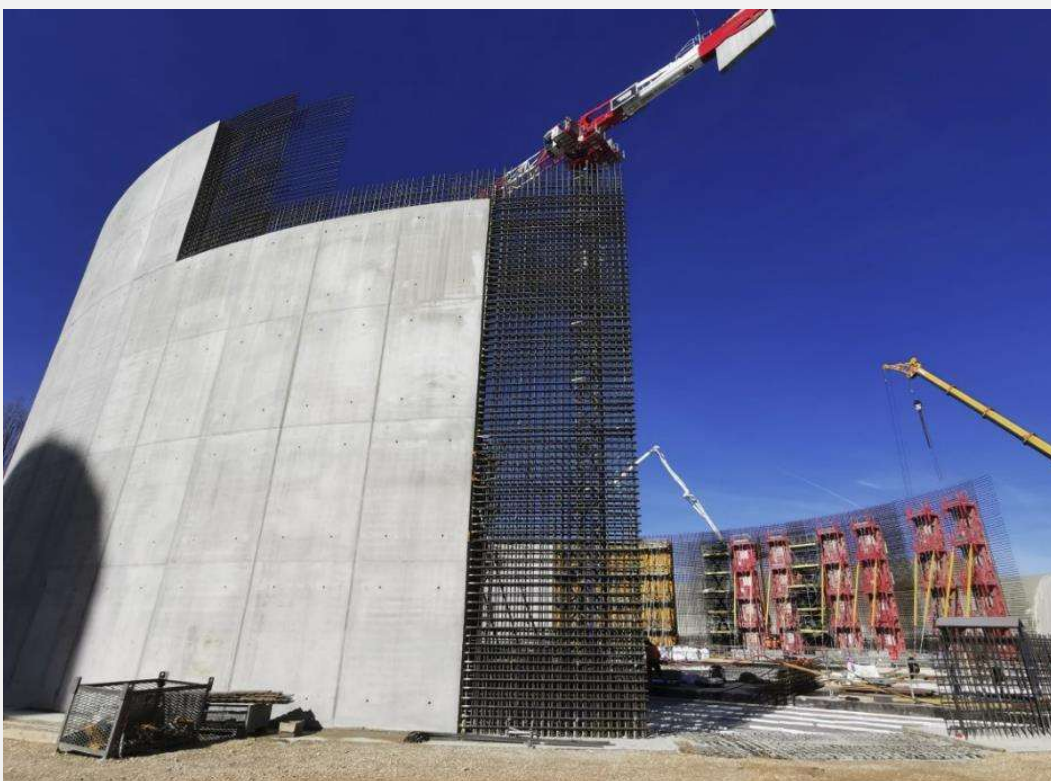

Etudes réalisées :

- Conception variante
- Réalisation des études d'exécution du génie civil

FULL BIM

juin-24



Référence instrumentation



SANEF – Projet OCTAV – Viaduc d'Echinghen

- Partenariat surveillance acoustique

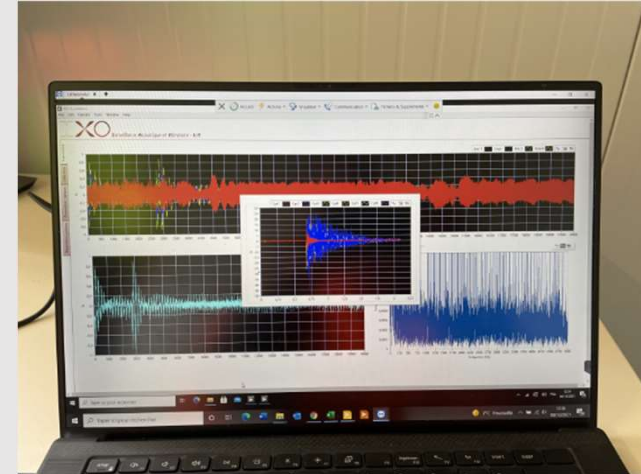

juin-24



Référence instrumentation



ESCOTA – A8 – Viaduc de Cagnes-sur-Mer

Instrumentation des appuis cantilever pour la détection de fissures internes

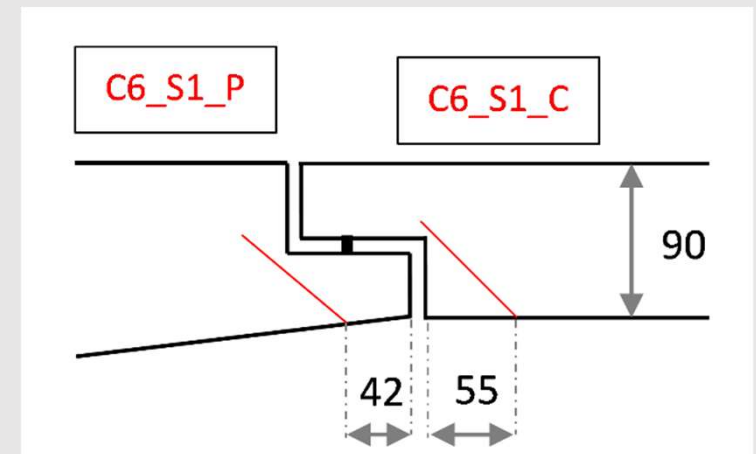
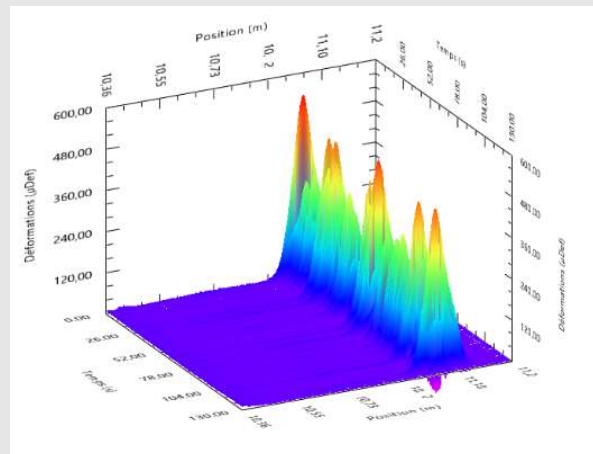
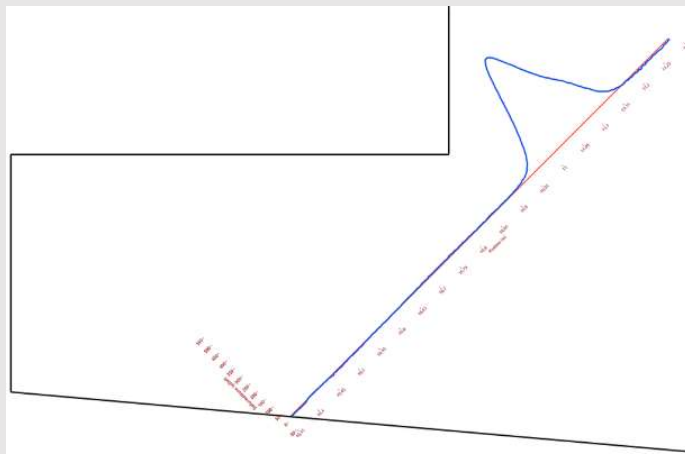
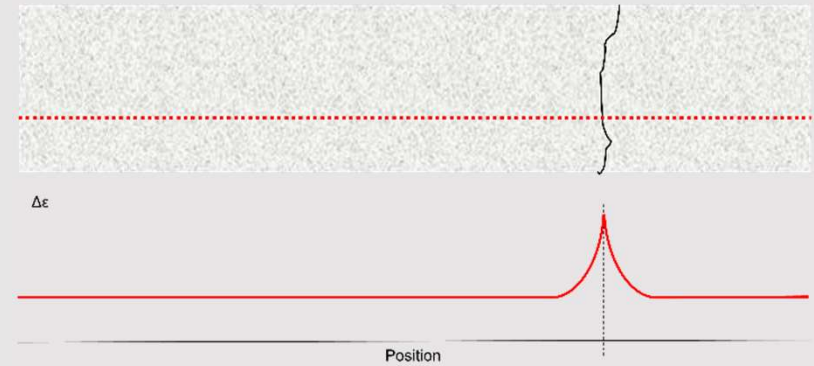



Référence calcul et instrumentation



APRR / AEVIA – Expertise technique pont haubané Viaduc de l'Isère – A49

- Etude de l'impact de l'état des haubans sur la portance générale de l'ouvrage
- Coupler l'analyse calculatoire avec une instrumentation ajustée

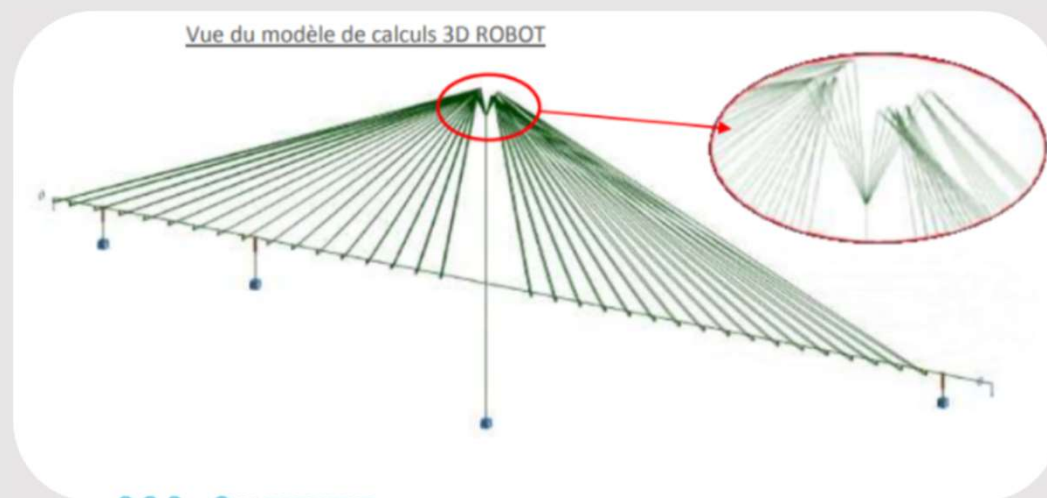

juin-24



Référence calcul et instrumentation



ASF - AMO pour la mise sous haute surveillance des viaducs de l'Hyrôme et du Layon – A87 (atteints de RSI)

- Modélisations détaillées et définition des plans d'action en vue de la mise sous haute surveillance,
- Définition des seuils de pré-alerte et d'alerte,
- Optimisation des systèmes d'instrumentation,
- Mise au point des protocoles d'exploitation,
- Caractérisation de la performance actuelle des ouvrages.

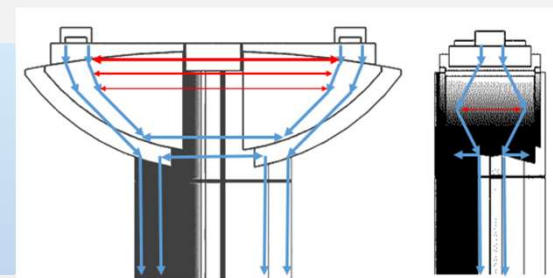
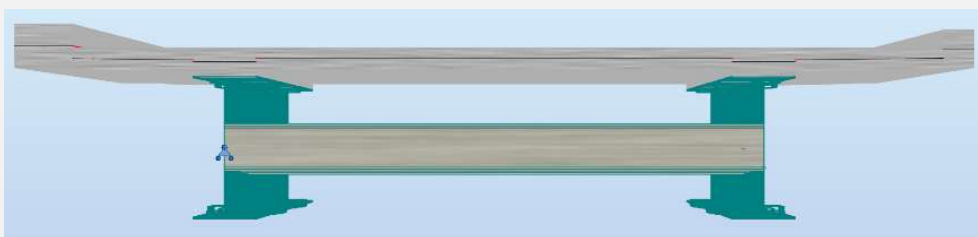
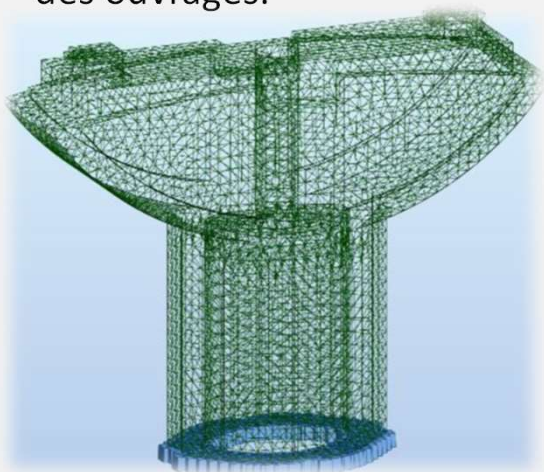

APRR – A6 Viaduc d’Ouche

- Ingénierie VISA
- Comité d’expert BFUP (Adrien ROIBET)
- Instrumentation :
 - Etanchéité – Dalle d’Essai BFUP
 - Structurelle – 330m de CFOD en talon

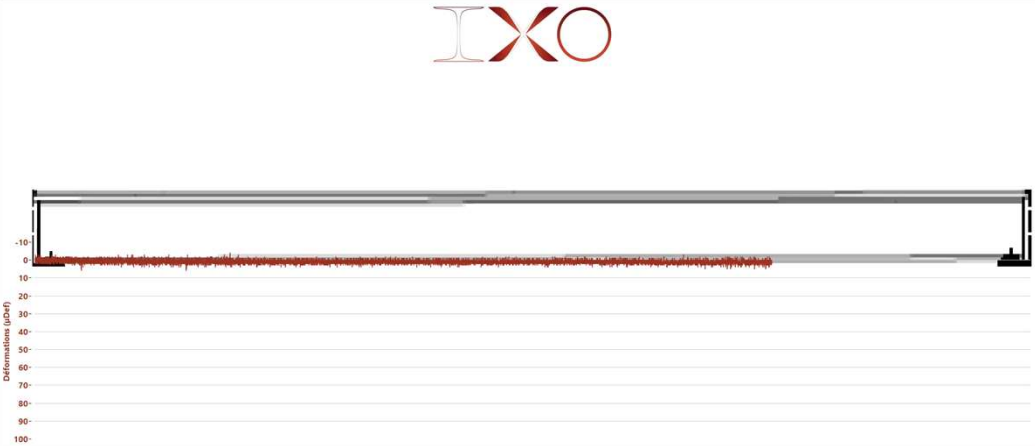
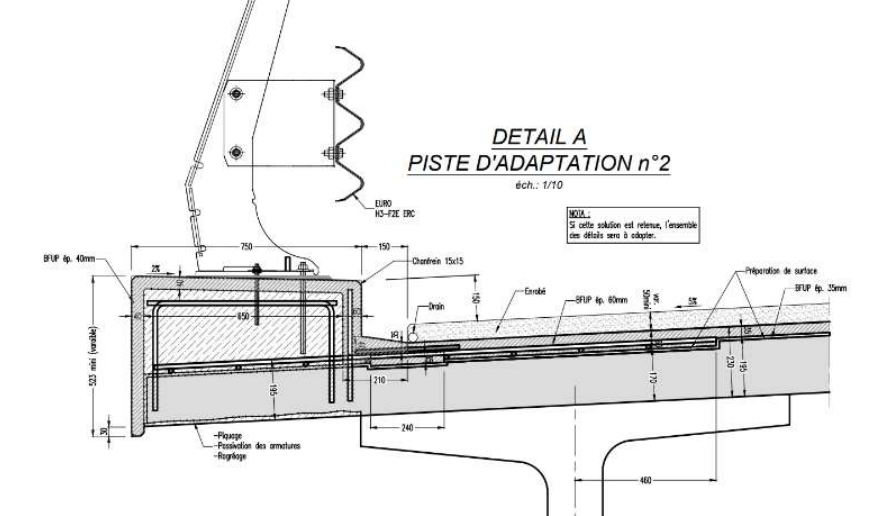

IXO Référence réparation – étude - instrumentation



APRR – A6 Viaduc d'Ouche



juin-24



Référence étude conception



COFIROUTE – Expertise préliminaire de l'élargissement A28 sur OA (PI et PS)

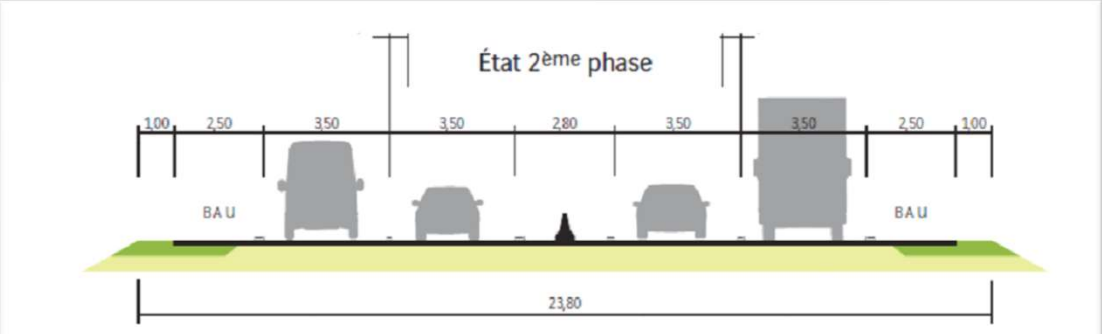

Profil cible section courante

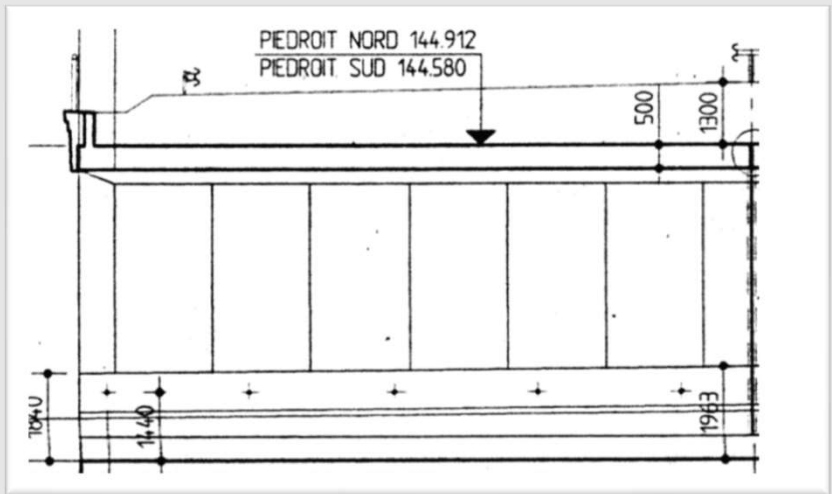
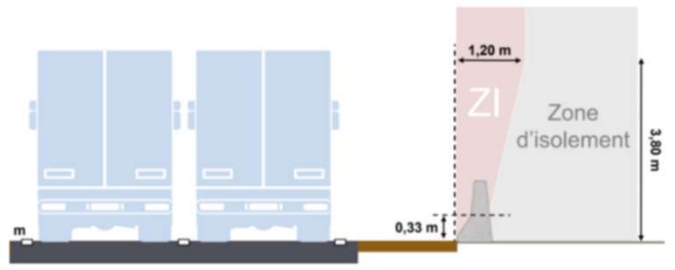



Référence étude conception

ASF – Echangeur A8-A51 – Contrôle extérieur Etudes OA

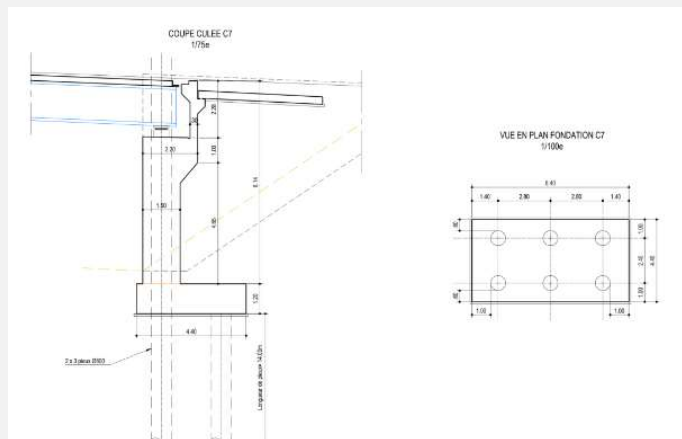
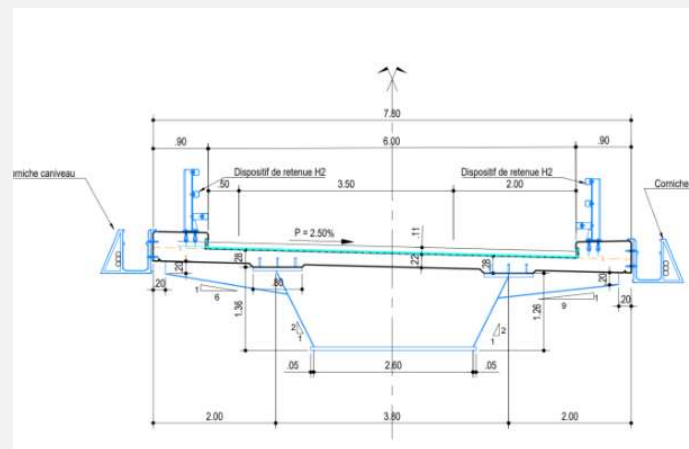

juin-24



ETU_ICI_PL_00003_D.dwg

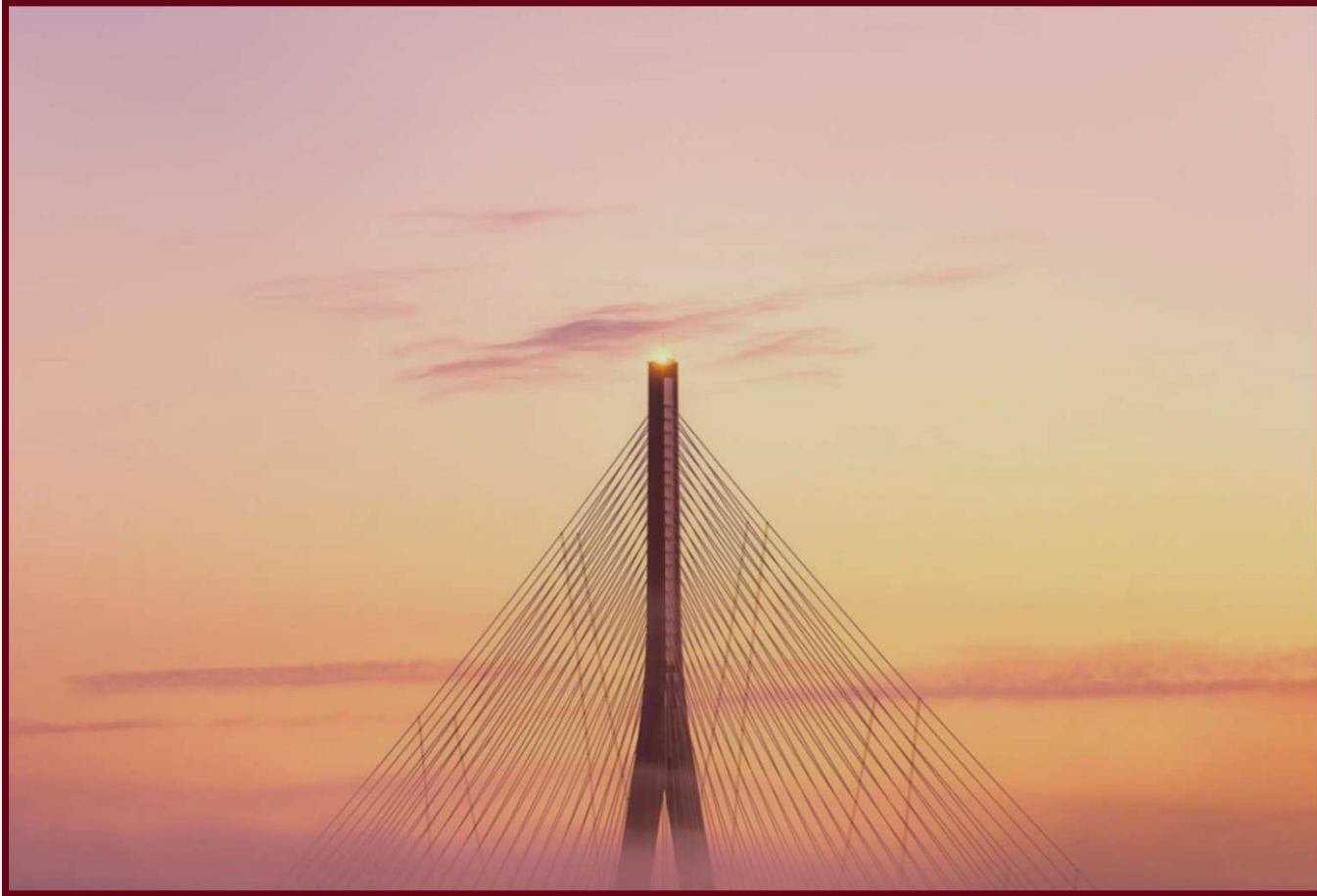

Ingénierie et eXpertise des Ouvrages

juin-24



Référence étude d'EXE spécifique

Grenoble Alpes Métropole / Freyssinet – Pont de Catane

- Etudes d'exécution (Note de calculs et plans)

Ouvrage atypique à bielles béton fichées des années 50
Vérinage complexe

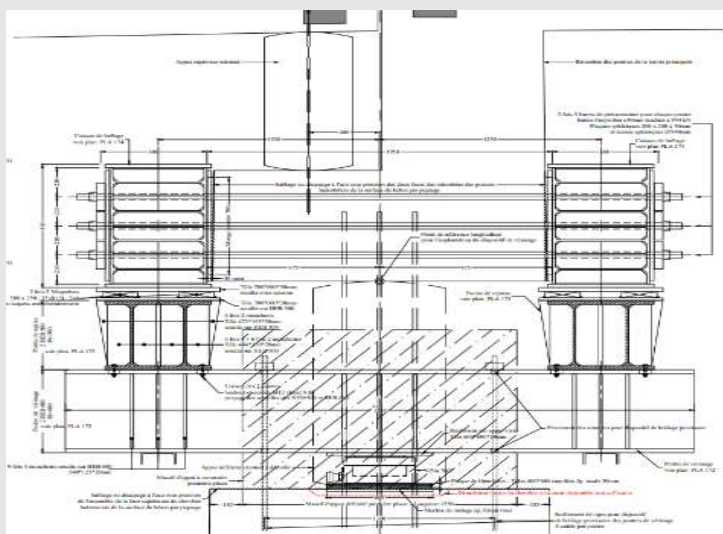
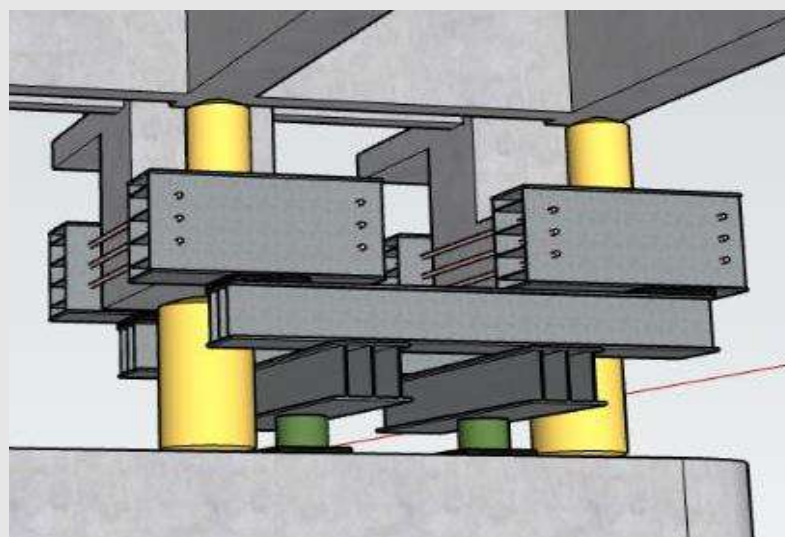
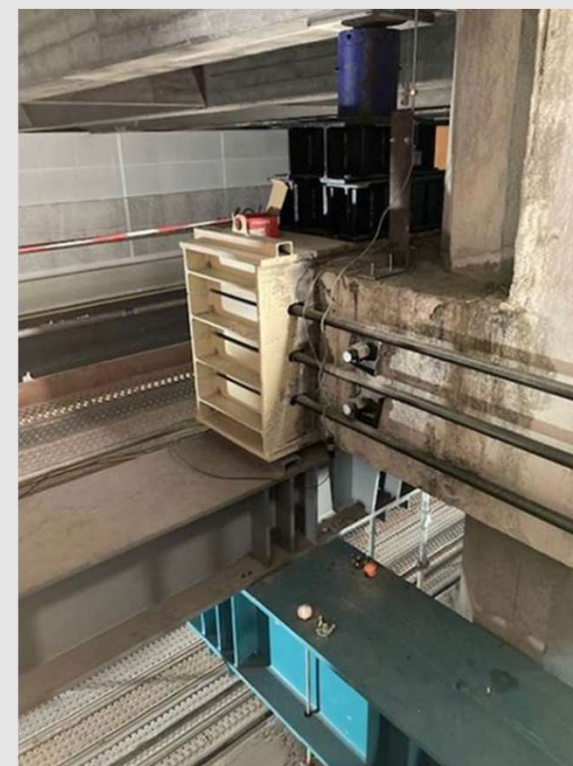



Référence calcul et instrumentation (préco)



SANEF – AEVIA – Expertise précontrainte sur PSDP – A26

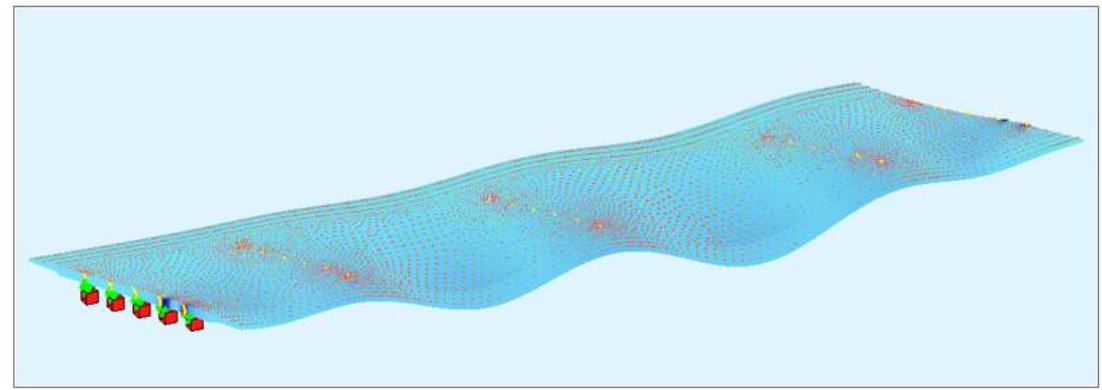

Vue 3D des déformations sous combinaison 1003

4.4.3. Variations de contraintes dans le tablier

L'effet combiné de la décompression et de la perte de moment de précontrainte dus à la suppression de 4s et 6s induisent en intrados et en extrados du tablier des variations de contraintes $\Delta\sigma = \frac{\Delta N}{S} + \frac{\Delta My}{I}$

En fibre sup :

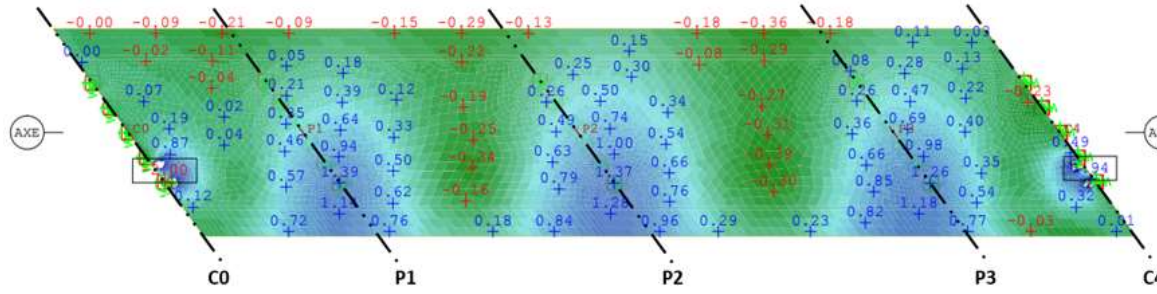

juin-24



Référence étude d'EXE spécifique



CD 30 / Baudin Chateauneuf – Pont de Brouzen

• Etudes d'exécution

- Principales vérifications:
 - Vérification des poutres en flexion longitudinale
 - Vérification du hourdis
 - Vérification des entretoises

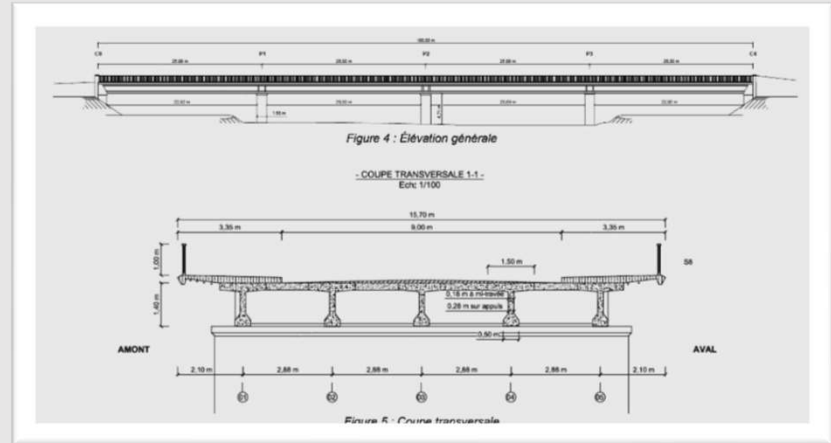

ELEVATION POUTRE 24.980m (x20) Ech -1/50

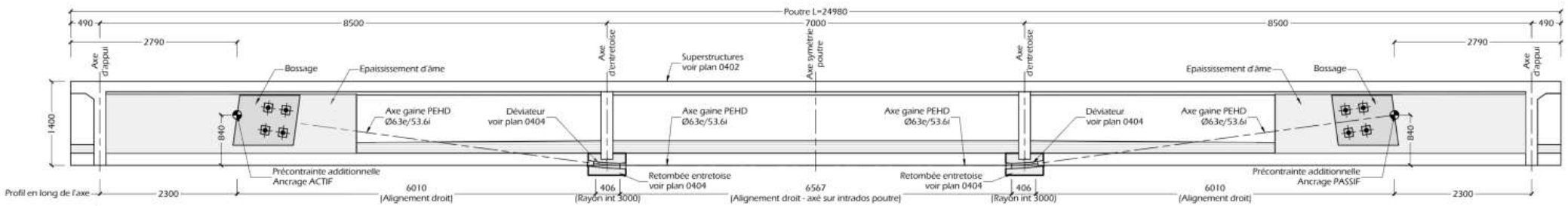



Référence Diagnostic - réparation



CD74 – Verchaix

- Diagnostic
- Investigations complémentaires
- Faisabilité
- Fissuration des poutres
- Projet de réaménagement chaussée (piste cyclable)

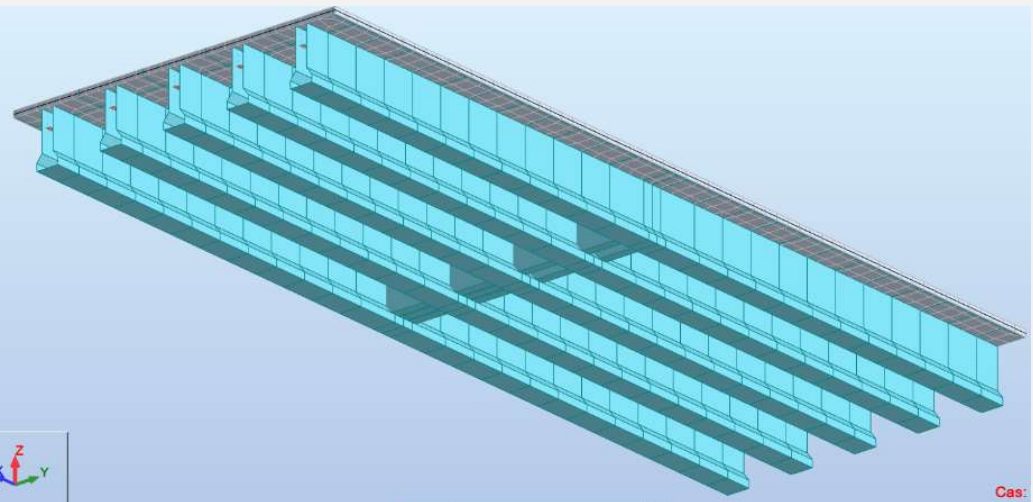

juin-24

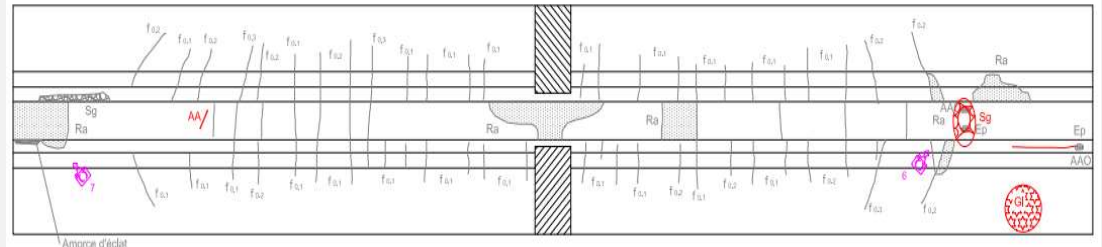
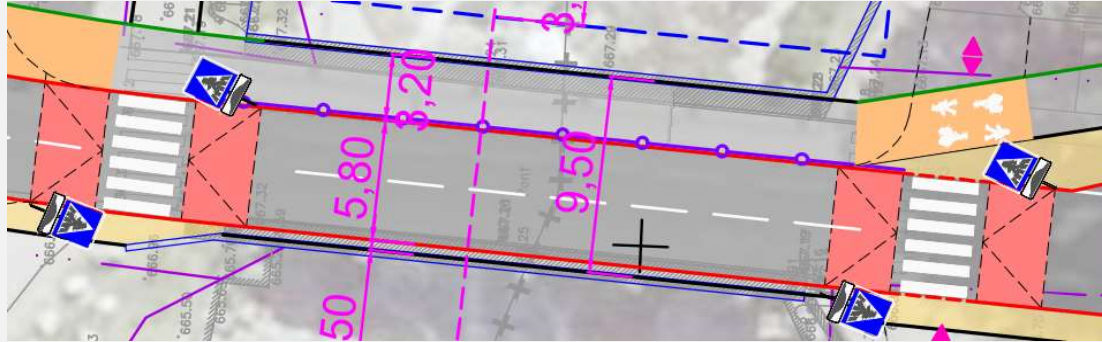



Référence Etudes EXE Variante



Pont du Verney (CD73) – Variante BFUP mixte

- Ouvrage mixte isostatique
- Variante hourdis BFUP (étanchéité ou dalle pleine)
- Variante fondations

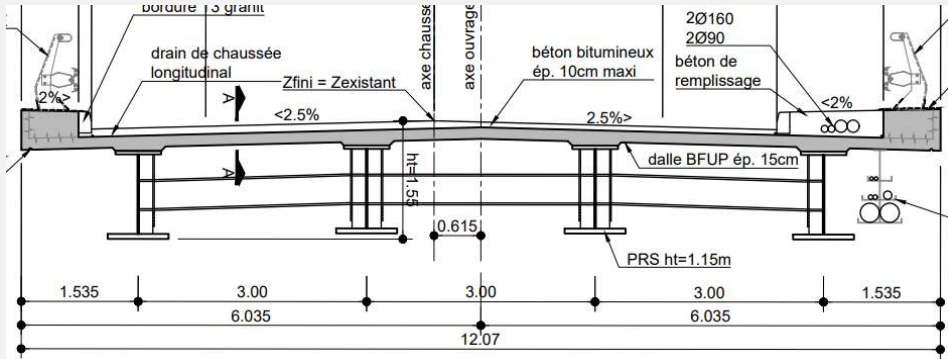

Variante multipoutres + étanchéité BFUP

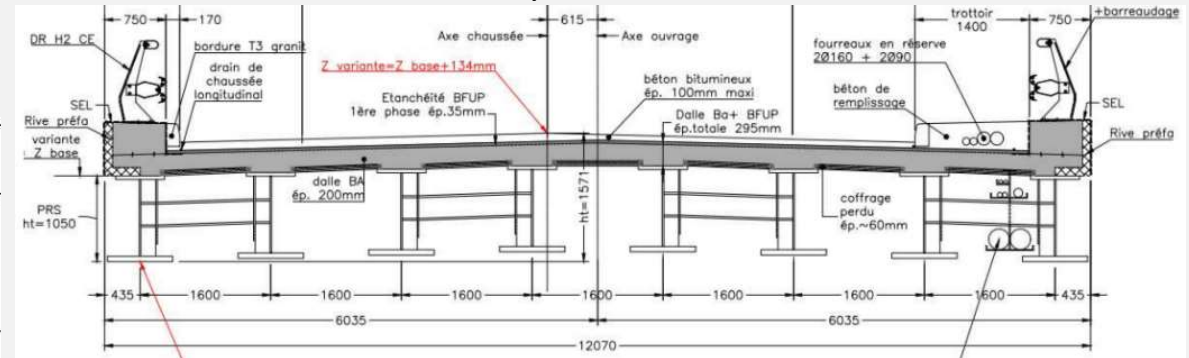

Variante mono file de pieux + dalle de frottement

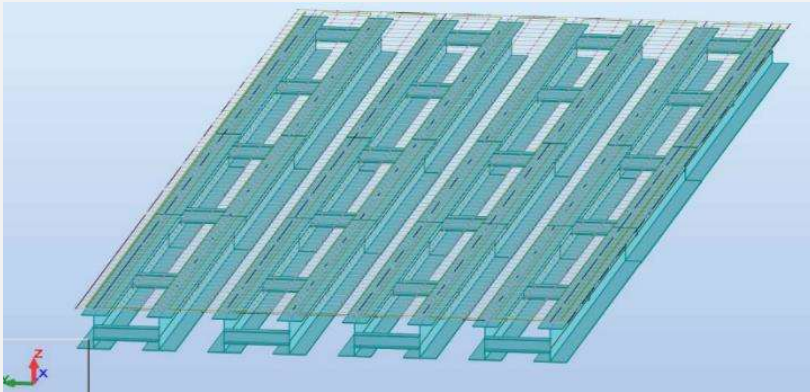
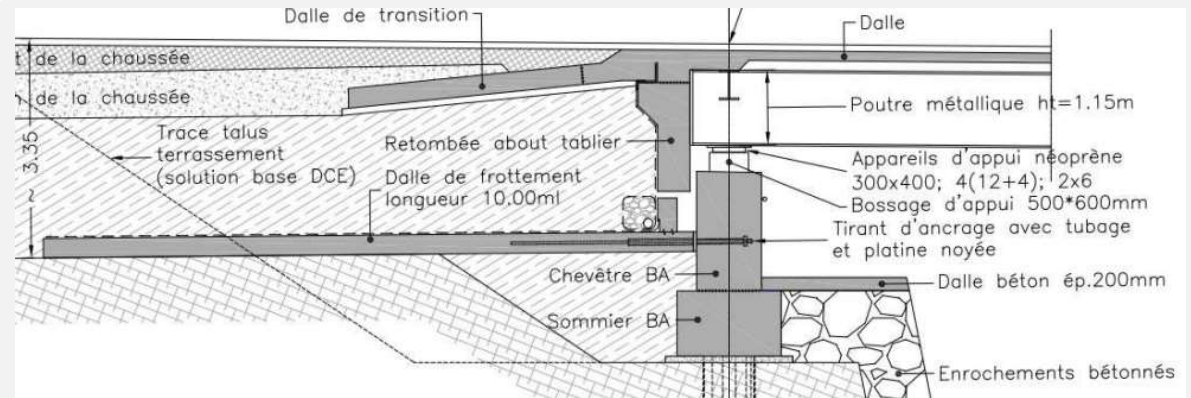



Référence étude d'EXE spécifique



BOUYGUES TP RF – Pont de Dallet – Réhabilitation et élargissement BFUP

- Etudes d'exécution (Note de calculs et plans)

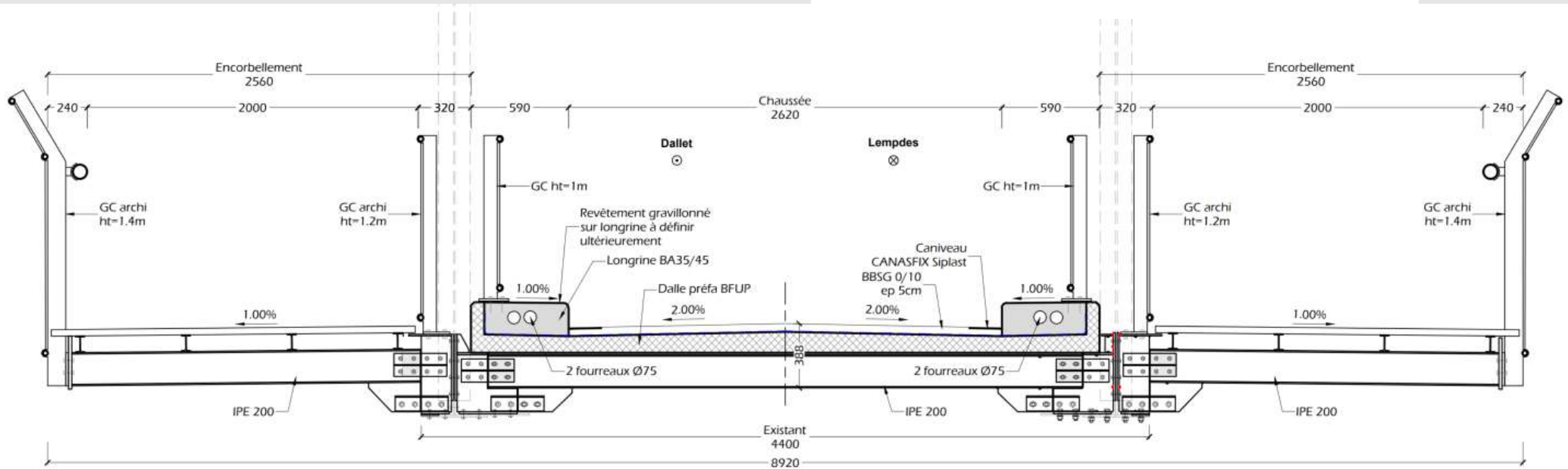
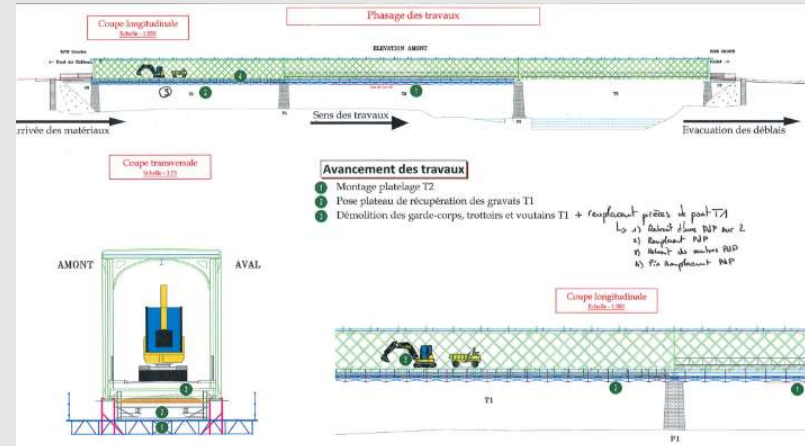



Référence étude d'EXE spécifique



CD 30 / Baudin Chateauneuf – Pont de Brouzen – EXE complètes

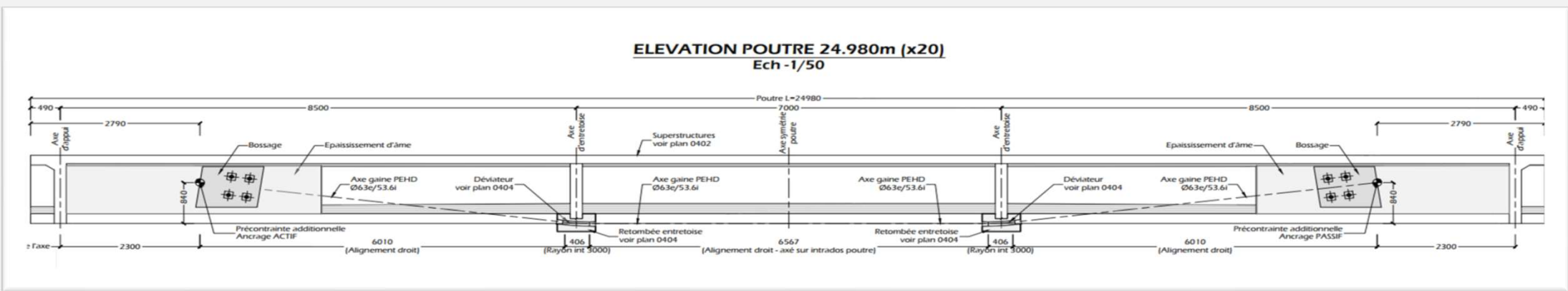
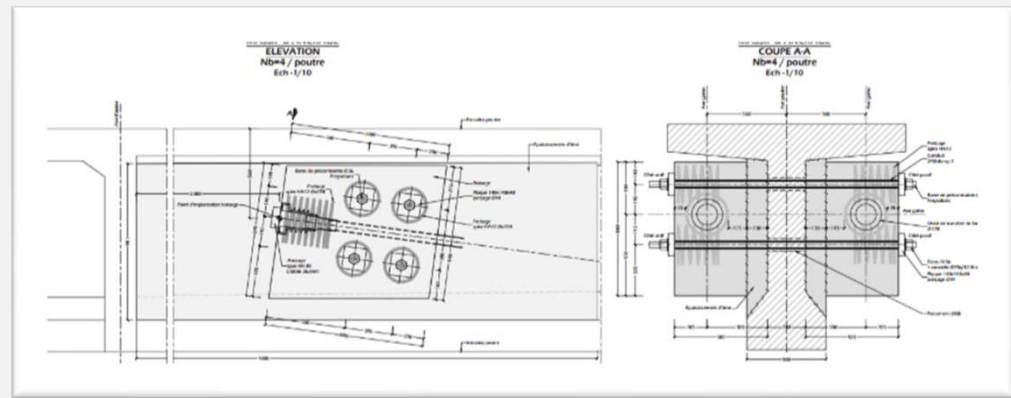
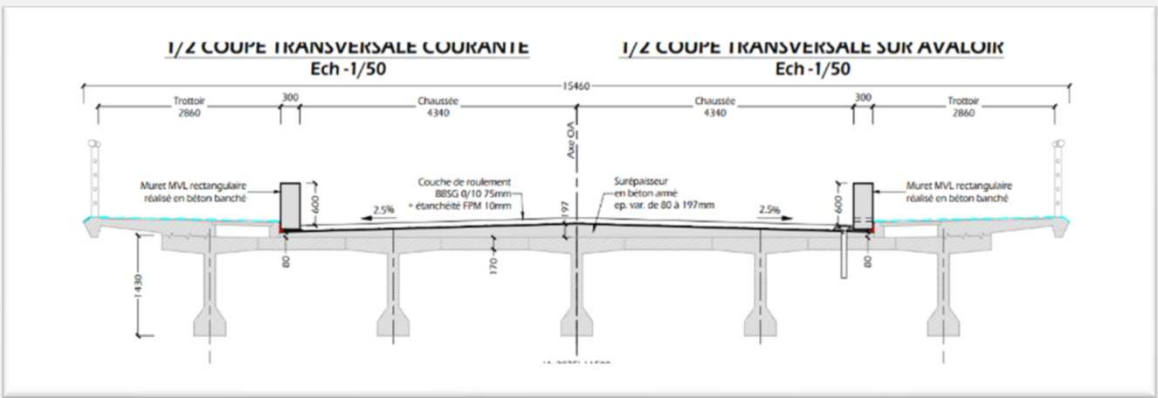

- Principales vérifications:
- Vérification des poutres en flexion longitudinale // hourdis // entretoises
 - Renforcement général par précontrainte additionnelle et carbone



Référence étude conception



VICAT – CBCE

Hall Clinker site de Montalieu
(10 M€ HT travaux)



juin-24

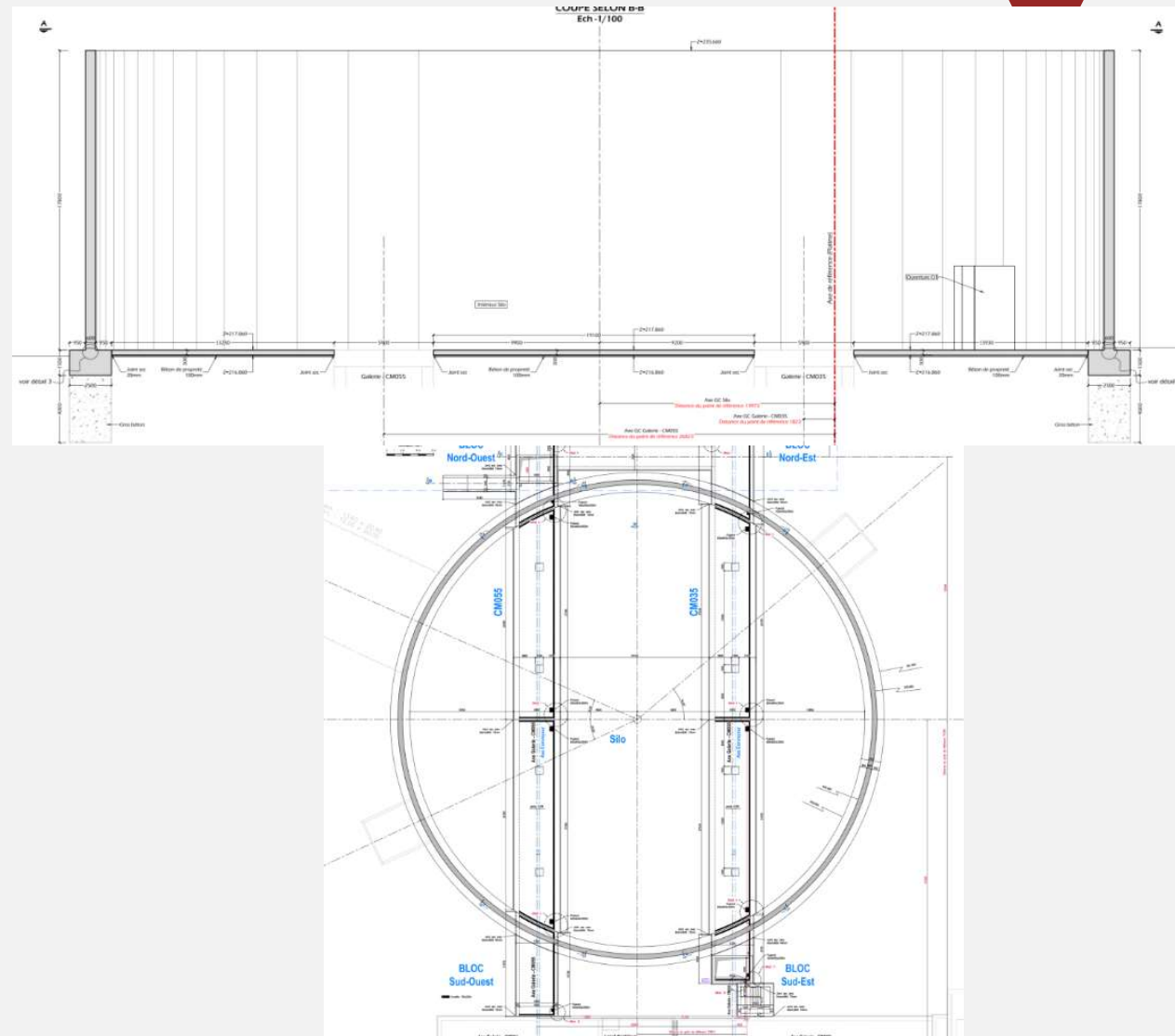



Référence étude d'EXE spécifique



Freyssinet Suisse – Expertise des Suspentes - Pont sur la Thielle

- Etudes d'exécution partielles

